



EC

**Operation and
Maintenance Manual**

Electric Torque Multiplier Series EC

Operation and Maintenance Manual

Foreword

Congratulations on your purchase of an *alkitronic® electric torque multiplier*. This high quality product sets unique international standards and satisfies high safety levels. In order to preserve these features, your assistance by regular maintenance is required. Please read this operation and maintenance manual carefully and observe the following information and instructions.

Maintenance and repair of the *alkitronic® torque multiplier* must be performed by the **alki TECHNIK GmbH** or certified workshops adequately trained and instructed by **alki TECHNIK GmbH**.

Improper maintenance may endanger your health and damage the unit. In addition, non-compliance of any above items will void all warranty claims!

This operation and maintenance manual includes basic information and instructions which must be observed during operation and maintenance. The operator must read and understand the basic precautions before operation or performing maintenance. It must always be available on site.

This operation and maintenance manual applies only to the *alkitronic® torque multiplier*.

Do not only observe the "Safety instructions" mentioned in "Definition of symbols", but also all other special instructions and hints in other sections.

Definition of Symbols



Safety instructions, which by non-compliance may result in personal injury or death.



Safety instructions, which by non-compliance may result in damage to the *alkitronic® torque multiplier*, its functions or the environment.



Information for proper and safe operation.



Practical advice and information to make work easier.

Content Table

	Page
A Reception Control and Packaging	3
B General Description	3
B1 Model Description	3
1. Technical Data	4
2. Safety Instructions	4
2.1 Intended use	4
2.2 Operators responsibilities	4
2.3 Possible hazards	4
3. Operation	5
3.1 Placing tool in operation	5
3.2 Preparing for bolting	5
4. Electric Operation	6
4.1 Operation all EC Models	6
4.2 Operating area with OLED display	6
4.3 Overview bolting programs (modes)	6
4.4 Bolting programs	7
4.4.1 Bolting according to the torque method	7
4.4.2 Bolting according to the combined torque/angle method	8
4.4.3 Bolting according to the combined torque/angle method - Premium	9
4.4.4 Bolting with specification of turns	10
4.4.5 Documentation bolted joint and Bluetooth activation	11
4.4.6 The <i>alkitronic® APP</i>	12
4.4.7 Error messages in the <i>EC</i> operating area	15
4.4.8 General warnings	15
5. Mechanic Operation	16
5.1 Tightening and loosening	16
5.1.1 Models EC-S / EC-A (axial drive)	16
5.1.2 Models EC-R / EC-SG (radial/tangential drive)	17
6. Ending or Interrupting the Work	18
7. Functional and Operational Tests	18
7.1 Optical and mechanical inspection	18
8. Service / Storage / Maintenance	18
8.1 Accessories change	18
8.2 Storage	18
8.3 Taking out of operation	18
8.4 Maintenance intervals	19
9. Technical Notes	19
10. Acoustic Emission and Vibration	19
11. Declaration of Conformity	19
12. Appendix	19
Replacing the power cord plug	20
Technical Data	21
Additional Safety Instructions	22

A Reception Control and Packaging



IMPORTANT!

Visually inspect all components for possible damage. If shipping damage is found, notify the forwarding **alkitronic® Partner** immediately. Return components and **alkitronic® electric torque multiplier** in original package to avoid additional damage. Therefore, please keep the packaging.

B General Description

alkitronic® electric torque multiplier are strength power-operated torque multipliers for continuously tightening or loosening heavy duty bolt connections.

The torque multiplier turns off with achievement of a demanded value or final torque.

The drive is done by a maintenance-free, low-wear synchronised motor without brushes and excellent efficiency, large torque range and high assembly speed.

Consistent torque accuracy in all international power supplies. Precise shut-off torque at operation with voltage-controlled portable generators.

B 1 Model Description

alkitronic® electric torque multiplier with axial drive.

The 360 degree rotating handle ensures comfortable operation. Robust motor housing of cast aluminium, electric protection class IP 54 for safe work in any weather (moisture, rain).

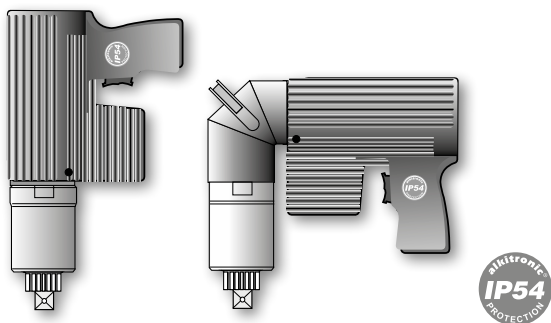

alkitronic® EC-S - torques up to 6,530 Nm / 4,800 ft.lbs*

alkitronic® EC-A angle tools for restricted access - high operating comfort. Torque values are the same as model **EC-S** with additional equipment: OLED-Display, menu guidance and bolting programmes as for example combined torque/angle procedure.

Innovative motor protection with automatic switch-off to secure the bolting quality.

* approx. values / torque values are dependent on model

alkitronic® electric torque multiplier with axial drive, for heavy goods vehicles and low seated boltings. 360 degree rotating handle for comfortable use, housing of cast aluminium, electric protection class IP 54.

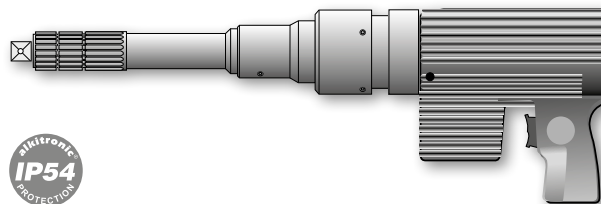

alkitronic® EC-N - torques up to 2,900 Nm / 2,825 ft.lbs*, all models with overload protection.

alkitronic® EC-R / EC-SG with radial/tangential gearing e.g. for use with spindles or long threaded bolts in plate heat exchangers. Robust motor housing of aluminium or cast aluminium, electric protection class IP 54.

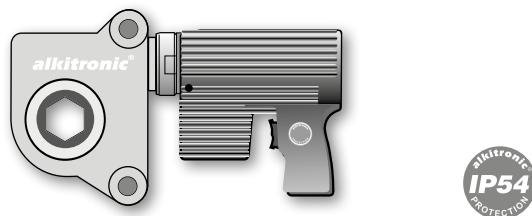

alkitronic® EC-R, protection class IP 54 standard, torques up to 3,840 Nm / 2,825 ft.lbs*.

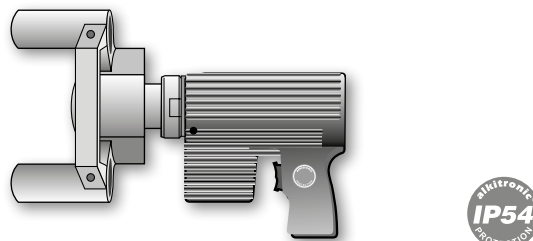

alkitronic® EC-SG, protection class IP 54 standard, constructively integrated reaction absorber, torques up to 3,780 Nm / 2,790 ft.lbs*.

Operation and Maintenance Manual

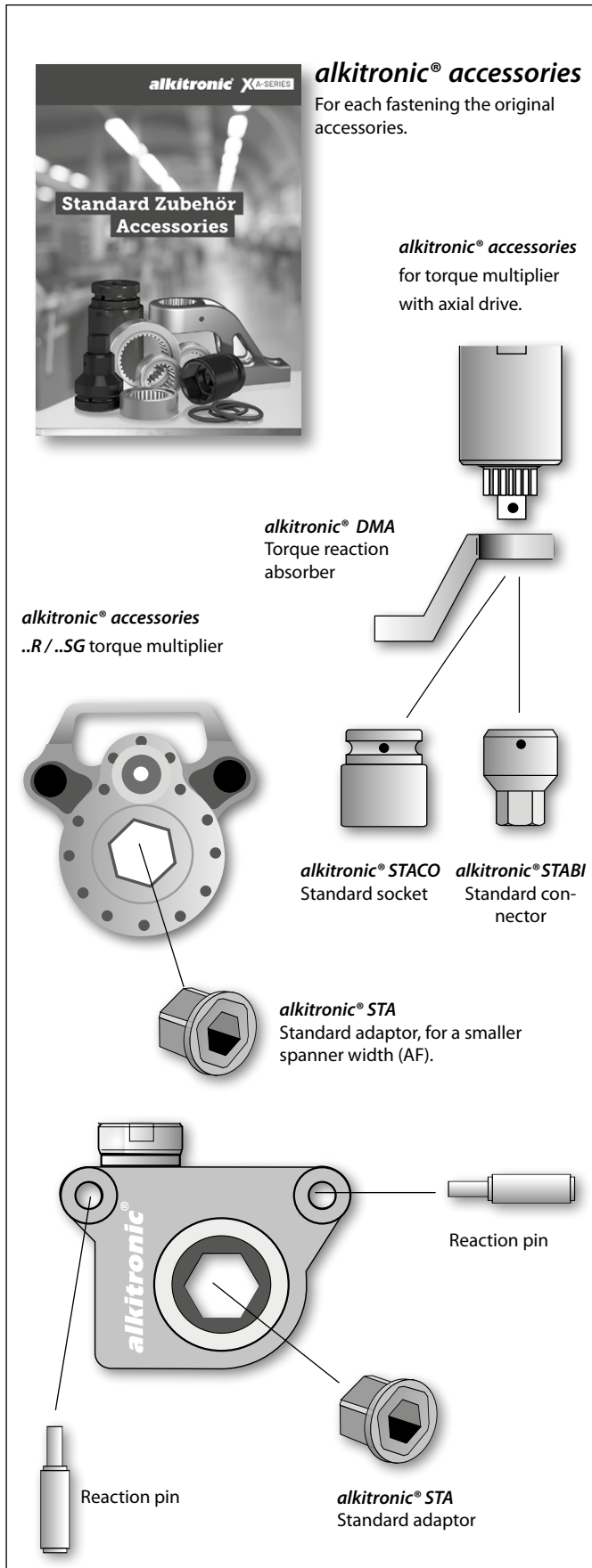

1. Technical Data

Supply voltage / frequency	100 V - 253 V / 45 Hz - 66 Hz
Nominal power max.	1100 W
Ambient temperature	-20° C to +50° C / -4° F to +122° F
Housing	Protection category I, IP-code 54
Repeat shut-off accuracy	± 2%

2. Safety Instructions

2.1 Intended use

alkitronic® torque multipliers are designed to tighten or loosen heavy duty bolt connections continuously. Do not use the torque multiplier for any other purpose than its intended use. For other applications please consult **alki TECHNIK GmbH**.

2.2 Operators responsibilities

The operator must have read and understood the instructions of this operation and maintenance manual before using or servicing the **alkitronic® torque multiplier**. Minimum age of the operator must be 18 years.

Operation and service may not be performed, if the concerned person does not understand purpose, consequences and precise performance of each procedure. For questions regarding the safety measures and areas of application, your **alkitronic® Partner** will be pleased to assist.



DANGER!

Improper operation, incorrect application, abuse or use by unqualified personnel may be hazardous to other persons, operator, torque multiplier and other property.



IMPORTANT!

The operator is responsible to third parties within the work area. Keep children and bystanders away while operating the torque multiplier.



DANGER!

Do not operate **alkitronic® torque multipliers** in explosive atmospheres, such as in the presence of flammable liquids, gases, or dust. For operation outdoors or in humid rooms, observe the relevant regulations.



CAUTION!

Non-authorized alterations and modifications of the torque multiplier are not permitted.

2.3 Possible hazards



DANGER!

Maintain the **alkitronic® electric torque multiplier**. Check breakage of parts/accessories, damaged power supply cord and any other condition that may affect the tool operation. In case of damages the torque multiplier must immediately be inspected by a qualified technician for electrical safety and mechanical defects (repairs may only be performed

by an alki TECHNIK GmbH certified and authorised personnel). All safety and mechanical defects must be resolved before resuming operation. For the avoidance of electric shocks or malfunctions admitted and accordingly marked extension cords are to be used outside only.

3. Operation



Prior to electric power connection, it must be ensured that the indicated technical data on the tool type plate as well as in the operation manual corresponds with the power supply and environmental conditions. Deviating values could lead to malfunctions or severe damages.

All *alkitronic® torque multipliers* are delivered with a three-wired power cord with ground conductor. A possible exchange of the power cord plug (caused by nationally different electricity supply or net plugs) may be performed only by an authorised electrician. See appendix "Replacing the power cord plug".



alkitronic® electric torque multipliers without "Protection class IP54" must not be operated in moist or humid environment otherwise an additional rain protection must be provided on site.



In case of machine malfunction or loss of electricity switch off power button immediately and disconnect the plug from the power source.

3.1 Placing tool in operation

alkitronic® STACO/STABI/STA/DMA (specific nuts, connectors, adaptors and reaction absorbers) available as accessories, are needed in accordance with a specific bolt joint.



The torque multiplier must be disconnected from the power source before making any adjustments or changing accessories.

- Accessories may be placed on the tool drive side. Make sure every part is placed correct and secured (in compliance with item 3.2 Preparing for bolting).
- Replace worn or damaged accessories immediately. For replacement use original *alkitronic®* accessories only. This rule will reduce the risk of malfunction and serious personal injury.

3.2 Preparing for bolting - Models with axial gearing

- Place the *alkitronic® torque multiplier* on a flat surface.
- If the *DMA* is secured with a safety screw, screw out safety screw completely (the position of the screw can vary dependent on type).
- Insert *DMA* reaction absorber (1) onto tooting (4);
- Screw in safety screw completely again - the *DMA* is secured.

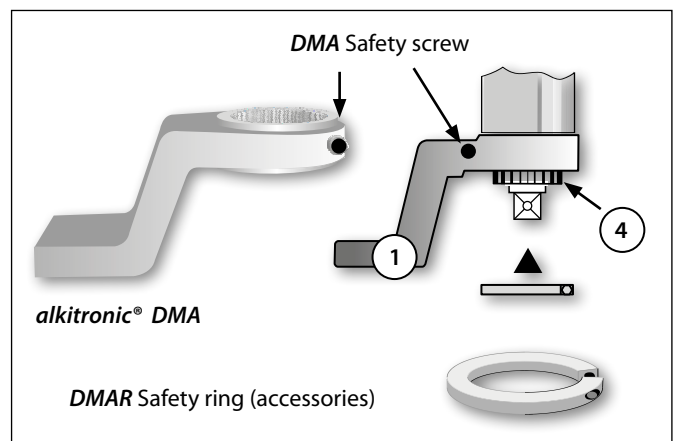

For a *DMA* without safety screw a safety ring *DMAR* is obtainable as accessory. The safety ring prevents the *DMA* from loosening and can be put additionally on the tooting and be screwed together.

- Put *STACO/STABI* (2)/(3) on square drive (both boreholes, adaptor and square must correspond).
- Insert safety pin (7), secure with rubber ring (6).
- *STABI*: screw in safety screw (8) completely.

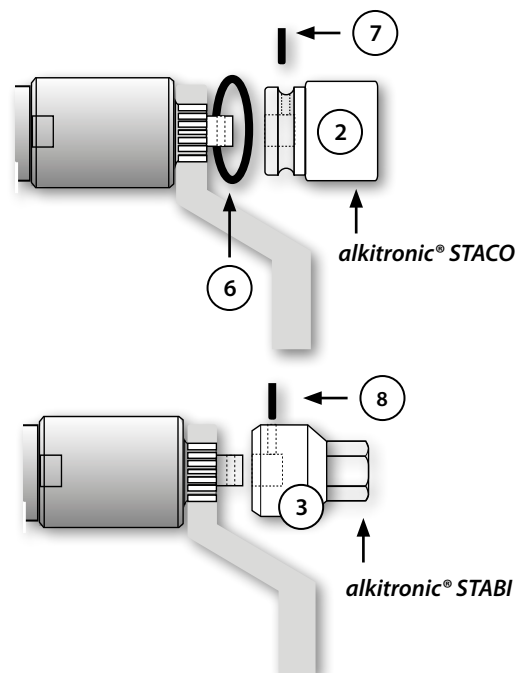

Operation and Maintenance Manual

4. Electric Operation

4.1 Operating unit (all *alkitronic*® EC Models)

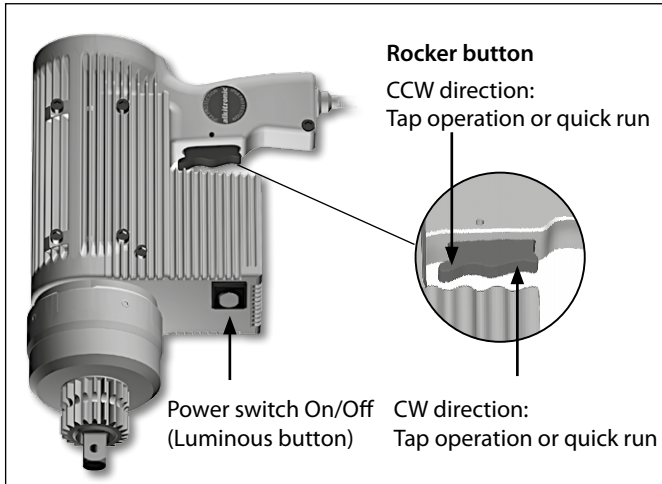

Bolting process with the rocker button

Action point below: CW direction - tap operation
Action point above: CCW direction - tap operation
In case the rocker button is pressed down continuously the torque multiplier changes over to standard operation (quick run). When releasing the rocker button the tool stops.

The torque multiplier shuts off precisely when reaching the required torque or value.



Never block the rocker button. A proper operation is not possible any more!

4.2 Operating area with OLED display

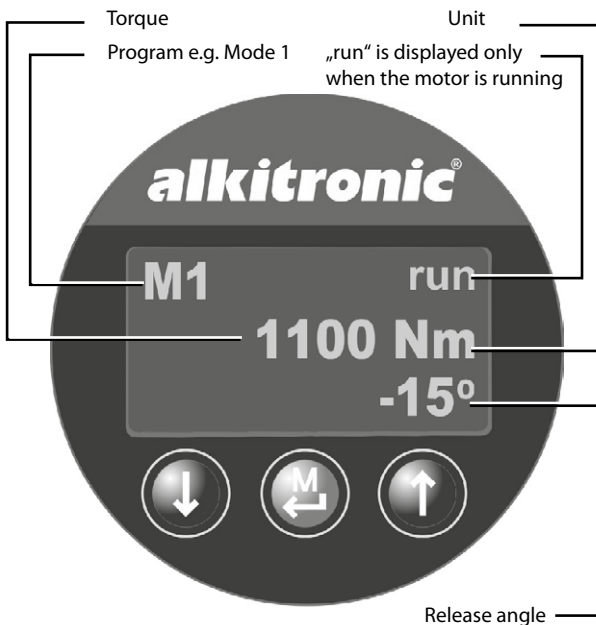

- Decrease value / line down
- Mode selection / input confirmation
- Increase value / line up

4.3 Overview bolting programs (modes)

Mode	Description
M 1	Bolting according to the torque method, automatic release with adjustable angle degrees.* Already included in the scope of delivery.

Optional programs:

M 2	Bolting according to the torque/angle method, automatic release function with presettable angle degrees. *
M 2 Premium	Additional adjustable torque limits
M 3	Bolting with presetting of revolutions and adjustable torque limitation.
M 5	Documentation of the bolting operations (target/actual status recording for each bolting operation performed). Bluetooth transmission via <i>alkitronic</i> ® APP.



* Caused by high torsional force it is often impossible repositioning the torque multiplier on the next screw joint. Therefore use the automatic release function to relieve stresses within the multiplier. The setting of angle degrees enables a "run free" of the reaction absorber DMA.

4.4 Bolting programs

4.4.1 Bolting according to the torque method

Settings mode 1 - with/without automatic release function

Start Screen



* After a short time, the display jumps to the next image (example).

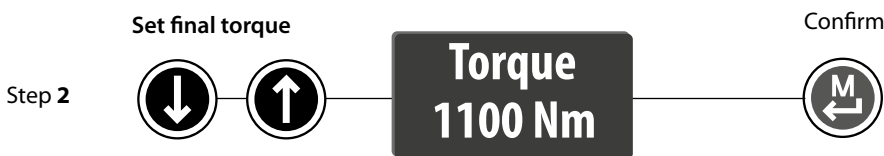

The setting steps of the torque values are in increments of 10 Nm (10 ft.lbs).

NOTE!

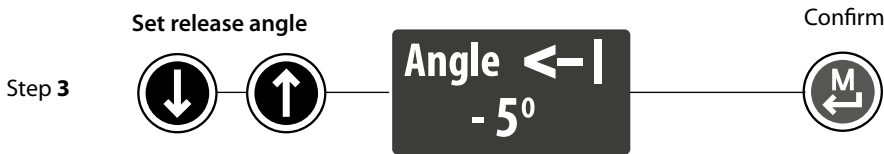

If no automatic release function is desired, set release angle to „0“.

Note on the procedure for the loosening angle: This is not intended for loosening a bolt/nut, here only the release of tension between the torque multiplier and the bolted joint is established!

Correction procedure: push key and return to step 1.



Once the values have been checked - start bolting process.

Successful bolting is signaled by „OK“.



Confirm resp. the acknowledgment is automatically.



Remove the torque multiplier, place it on the next bolt/nut and continue with the bolting process.

“nOK” signalisation flashes (faulty bolting).



Check the setting values. Repeat the bolting operation, observing the relevant regulations for the bolting operation, e.g. use new bolts or new bolting material.

Application description:

Bolted connections are bolted with a torque specification and monitored at the same time. During the bolting process, the currently applied torque is always shown on the display and reaching the SET value is signaled by an „OK“. The maximum actual torque

applied is stored. If required, an automatic release angle can be set. This function enables a fast, secure “run free” of the DMA and also relieves torsional stresses within the torque multiplier.

Operation and Maintenance Manual

4.4.2 Bolting according to the torque/angle method

Settings mode 2 - with / without automatic release function

Start Screen



* After a short time, the display jumps to the next image (example).



The setting steps of the torque values are in increments of 10 Nm (10 ft.lbs).

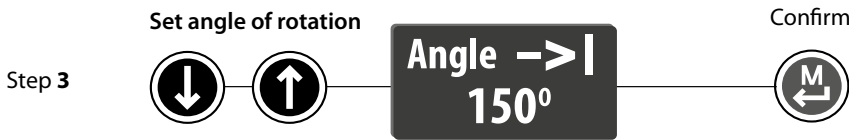

If no automatic release function is desired, set release angle to „0“.

Note on the procedure for the loosening angle: This is not intended for loosening a bolt/nut, here only the release of tension between the torque multiplier and the bolted joint is established!

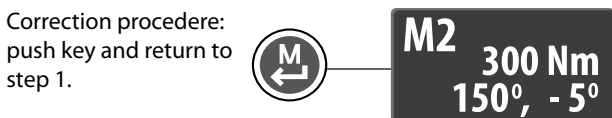

Once the values have been checked - start bolting process.



Confirm resp. the acknowledgment is automatically.

Remove the torque multiplier, place it on the next bolt/nut and continue with the bolting process.

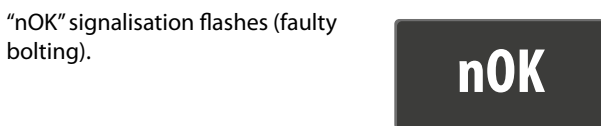

Possible causes: The angle of rotation was not reached. The torque output of the *alkitronic*[®] EC is not sufficient for the bolted joint. Check the setting values. Repeat the bolting operation, observing the relevant regulations for the bolting operation, e.g. use new bolts or new bolting material.

Application description:

Bolted connections are tightened using a torque specification and additional rotation angle specification and at the same time monitored.

In the torque specification, the currently applied actual torque is shown in the display. When the preset target torque value is reached, the torque multiplier automatically switches to the rotation angle func-

tion (the pushbutton must remain permanently activated).

The currently measured rotation angles are shown in the display and upon reaching the preset angle of rotation, an „OK“ is shown in the display. The maximum applied actual torque and the actual rotational angle are stored and evaluated with an „OK“ or „nOK“ in the display.

4.4.3 Bolting according to the torque/angle method - Premium

Settings mode 2 PREMIUM - torque limitation min / max. and with / without automatic release function

Start Screen



* After a short time, the display jumps to the next image (example).

Step 1

Set bolting method

↓ ↑

Set Mode M2

Confirm

Step 2

Set Pre-torque

↓ ↑

Torque 300 Nm

Confirm

Step 3

Set angle of rotation

↓ ↑

Angle → | 150°

Confirm

Step 4

Limitation: Set Torque min.

↓ ↑

MinTorque 1500 Nm

Confirm

Step 5

Limitation: Set Torque max.

↓ ↑

MaxTorque 2500 Nm

Confirm

Step 6

Set release angle

↓ ↑

Angle ← | -5°

Confirm

Correction procedure: push key and return to step 1.

←

M2 300 Nm 150°, -5°

Once the values have been checked - start bolting process.

Successful bolting is signaled by „OK“.

OK

Confirm resp. the acknowledgment is automatically.

Remove the torque multiplier, place it on the next bolt/nut and continue with the bolting process.

„nOK“ signalisation flashes (faulty bolting).

nOK

Possible causes: The angle of rotation was not reached. Termination due to exceeding the torque limit. The torque output of the *alkitronic*® EC is not sufficient for the bolted joint. Check the setting values. Repeat the bolting operation, observing the relevant regulations for the bolting operation, e.g. use new bolts or new bolting material.

NOTE! The setting steps of the torque values are in increments of 10 Nm (10 ft.lbs).

Limitation of max. torque

If no automatic release function is desired, set release angle to „0“.

Note on the procedure for the loosening angle: This is not intended for loosening a bolt/nut, here only the release of tension between the torque multiplier and the bolted joint is established!

Application description:

The bolting process is identical to mode 2, but a minimum and maximum torque value can be stored to protect the bolt/nut or the bolting process in general from overload and damage. The bolting process in the torque/rotation angle method is monitored and simultaneously limited with an adjustable minimum and maximum torque. The maxi-

mum selectable value corresponds to the maximum power range of the respective machine. If this torque value is exceeded during the bolting process, the process is aborted and evaluated with an „nOK“ in the display.

Operation and Maintenance Manual

4.4.4 Bolting with specification of turns

Settings Mode 3

Start screen

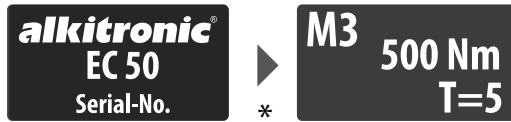

* After a short time, the display jumps to the next image (example).

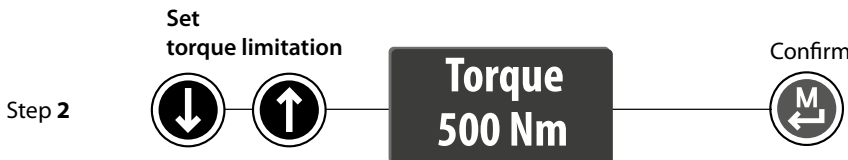

The setting steps of the torque values are in increments of 10 Nm (10 ft.lbs).



Correction procedure: push key and return to step 1.



Once the values have been checked - start bolting process.

The SET number of revolutions reached is signaled by „OK“.



Confirm resp. the acknowledgment is automatically.



Remove the torque multiplier, place it on the next bolt/nut and continue with the bolting process.

„nOK“ signalisation flashes (faulty bolting).



Possible causes:

Exceeding the torque limit or the torque output of the *alkitronic*[®] EC is not sufficient for the bolted joint. Check the setting values. Repeat the bolting process in compliance with the relevant regulations for the bolting process.

Typ <i>alkitronic</i> [®]	EC 10	EC 20	EC 30	EC 35	EC 40	EC 50	EC 60	EC 65	EC 70	EC 80	EC 90	EC 100
Turns maximal	416	228	175	112	79	74	57	43	37	23	22	17

Application description:

A certain number of revolutions is specified for the output drive. The torque limiter monitors the process at the same time. The currently measured number of revolutions is shown in the display. As long as the pushbutton is held down, the *alkitronic*[®] EC counts the revolutions already made until the set number of revolutions is reached. It is possible to pause the output. The currently measured number of revolutions is stored temporarily. When the pushbutton is pressed

again, the counter continues to run until the SET number of revolutions is reached.

Note:

However, the temporary storage is deleted when the mode is changed or the device is restarted.

When the number of revolutions is reached, the process is evaluated with an „OK“ in the display then recorded. If the set torque limit is exceeded, the process is aborted and a „nOK“ is shown then saved.

4.4.5 Documentation bolted joint and Bluetooth activation

Settings Mode 5

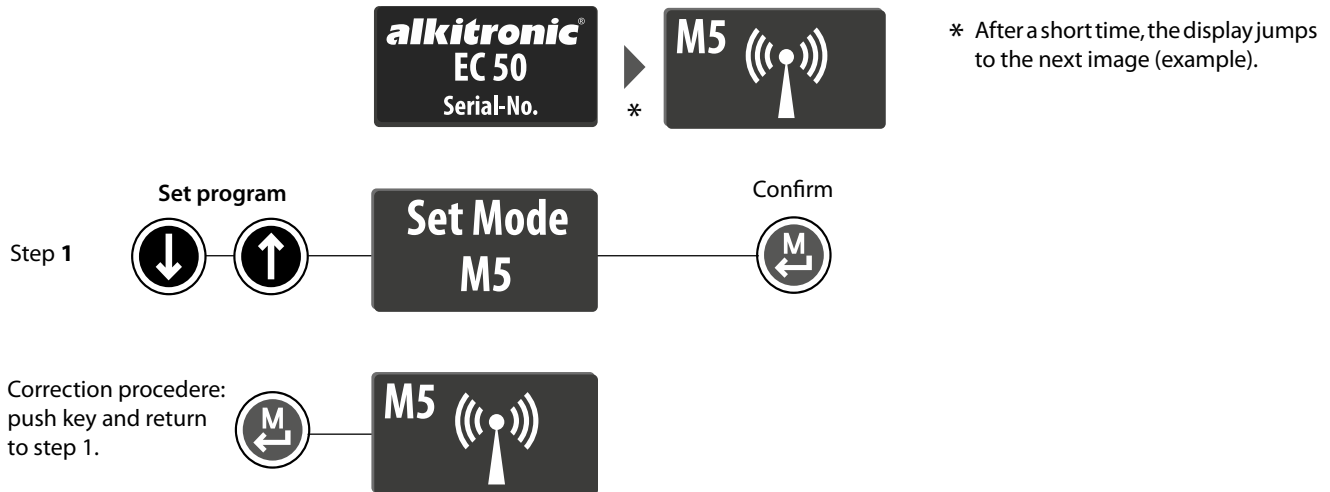

The Bluetooth interface on the phone/pad must be activated so that the **alkitronic® EC** can be paired.

Possibilities for data evaluation:

- In modes 1, 2 and 3, all bolting actions are documented
- In mode 2, the resulting maximum torque can also be reproduced during use in rotating angle application

Contents of the CSV file:

- ID** - consecutive number for each stored tightening
- Mode** - mode used
- Target / actual values** - used target values and measured actual values
- Status** - Assessment of target / actual values for tightening status (SUCCESSFUL / ERROR)

In the CSV file, under the column „actual torque“ you can find the final torque of the rotation angle function of mode 2. This value is used for the direct determination of an emerging torque range, for example for the use of test and development purposes in the bolting application.

CSV data set: Example mode 1 (ID33-35) with 3 bolted connections, target MD in Nm and release angle 5°. Example of mode 2 (ID36-38) with 3 bolts, target MD, min,max MD in Nm, target angle and release angle 5°.

ID	Mode	Timestamp	Status	ActualTorque	TargetTorque	MinTorque	MaxTorque	ActualAngle	TargetAngle	ActualTurn	TargetTurn	Actual Release.angle	Target Release.angle
33	1	2020-05-29F13:21:38.016Z	OK	298	301	---	---	---	---	---	---	5	5
34	1	2020-05-29F13:22:38.016Z	nOK	420	301	---	---	---	---	---	---	0	5
35	1	2020-05-29F13:22:38.016Z	OK	302	301	---	---	---	---	---	---	5	5
36	2	2020-05-29F13:24:38.016Z	nOK	270	140	200	250	50	50	---	---	0	5
37	2	2020-05-29F13:25:38.016Z	OK	244	140	200	250	50	50	---	---	5	5
38	2	2020-05-29F13:25:38.016Z	OK	235	140	200	250	50	50	---	---	5	5

Mode 2 Premium → Pre-Torque | M_D Limitation | Angle of Rotation | Release Angle

Legend: M_D = Torque

Application description:

Selecting mode 5 activates the Bluetooth interface and enables transmission. Provided Bluetooth is activated on the smartphone In the **alkitronic® App**, the relevant bolting cases for documentation can be narrowed down by selecting the desired download period (download from: date / time).

Up to 500 stored bolting joints can be downloaded with the associated **alkitronic® App** and sent by e-mail in the form of a CSV file. This makes the bolting data available in tabular form for analysis and documentation.

Operation and Maintenance Manual

4.4.6 The *alkitronic*® APP

Quick guide: Screens and selection of operating

You can find the *alkitronic*® app download in the App Store (Apple) or Play Store (Android).

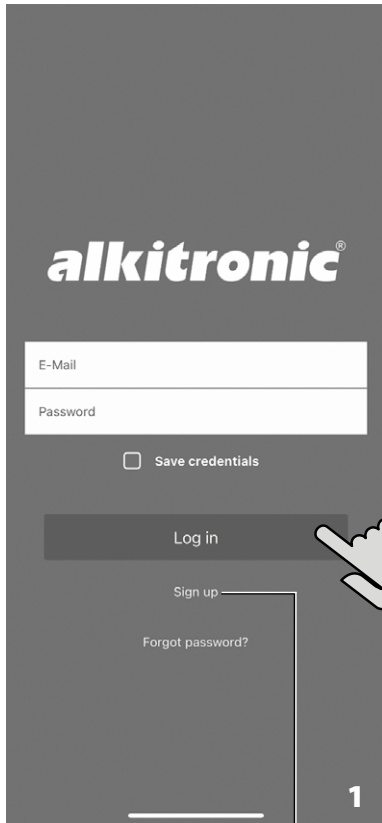

The screen views may differ from the images shown here, depending on the smartphone used.

← Log in

Language selection

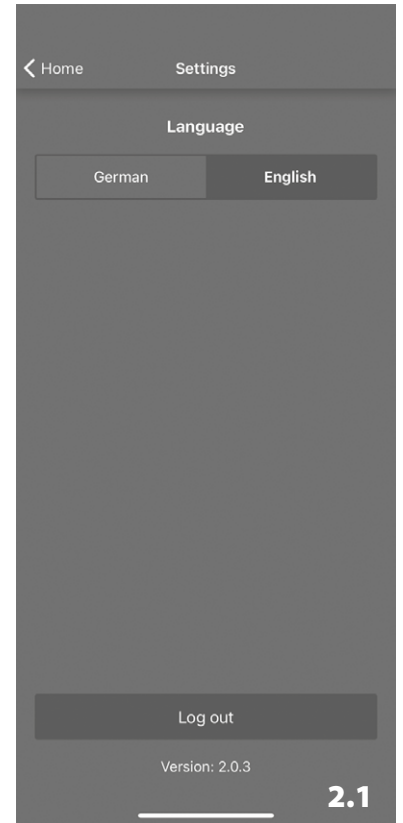
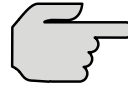

Torque multiplier choice *

Settings



Collection of user data

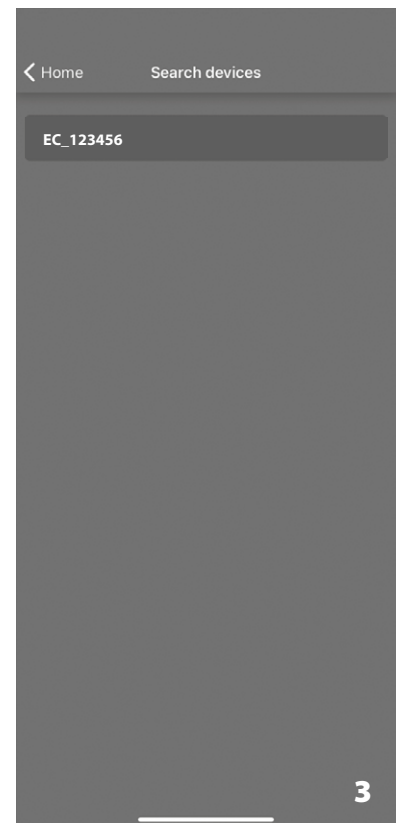
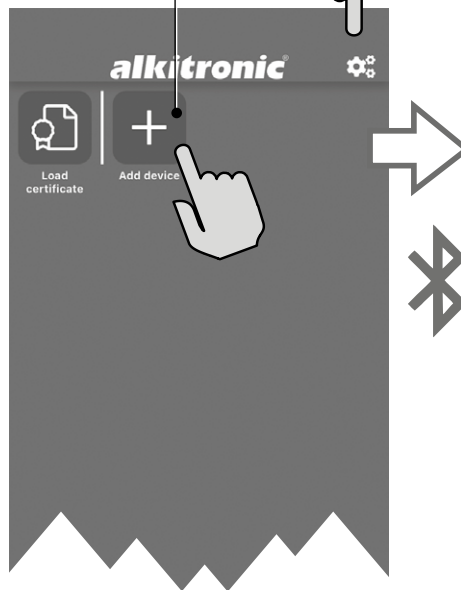
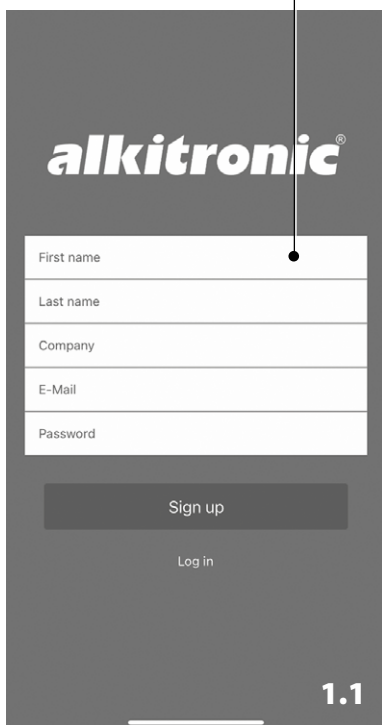

*) To pair or search for an *alkitronic*® EC torque multiplier, the Bluetooth interface on the phone/pad must be activated.

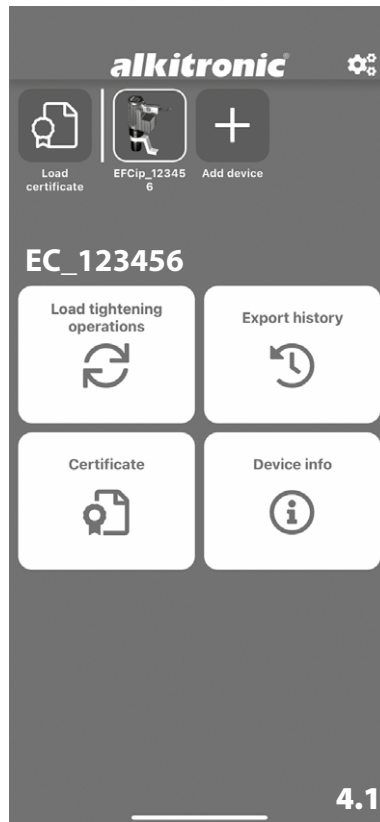
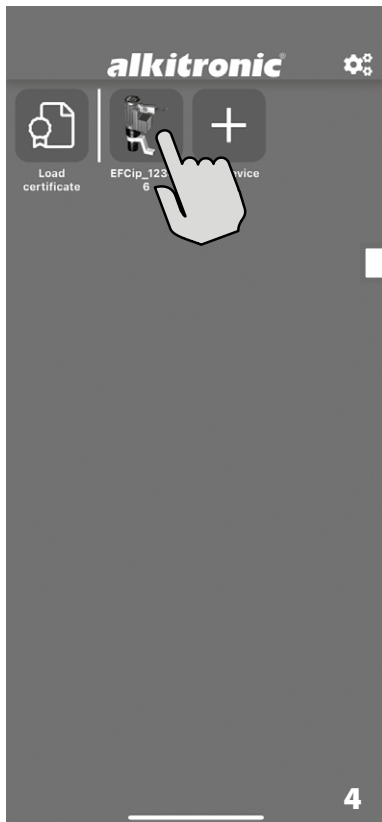

After the Torque Multiplier has been selected (Screen 4), all machine and production-related data can be called up.

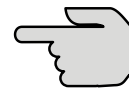

When tapping the CSV icon, the displayed bolted joint data (Screen 5.2) will be exported in a CSV data record.

Note:
After transferring the data, this overview is no longer displayed.

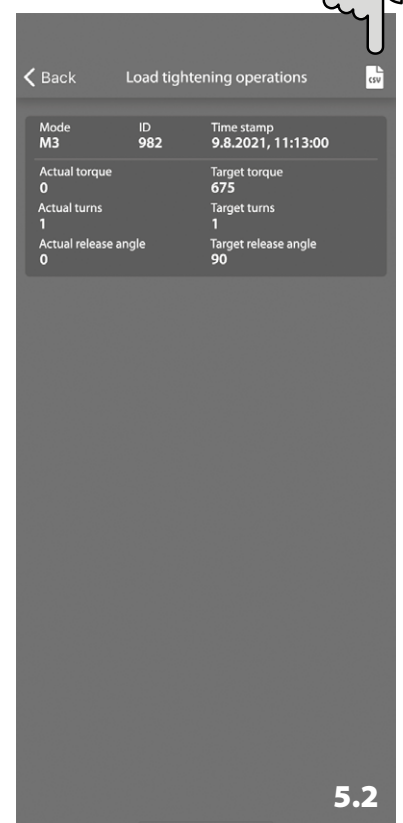
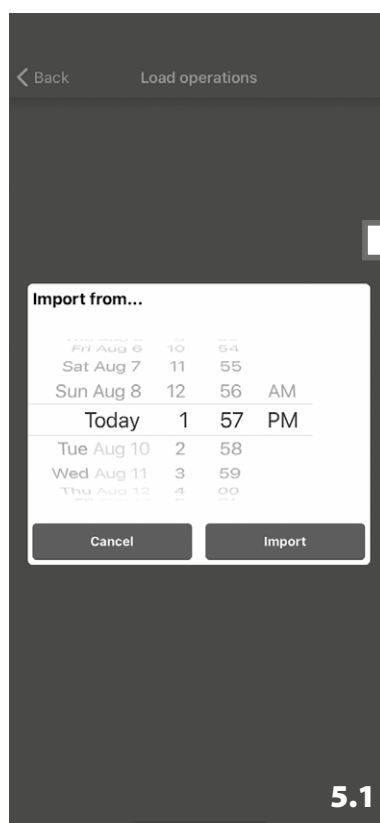
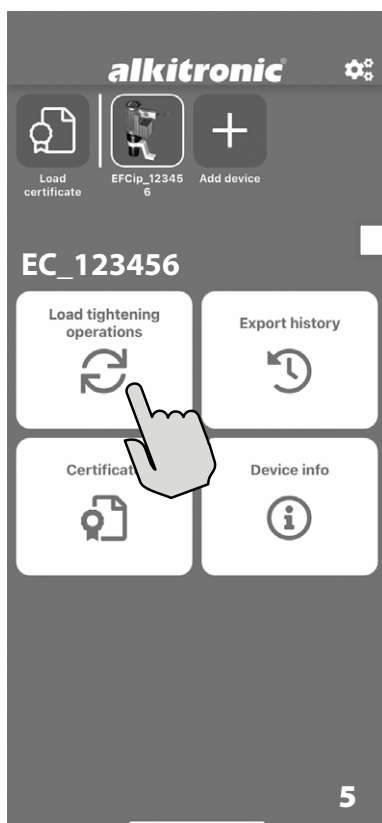

Operation and Maintenance Manual

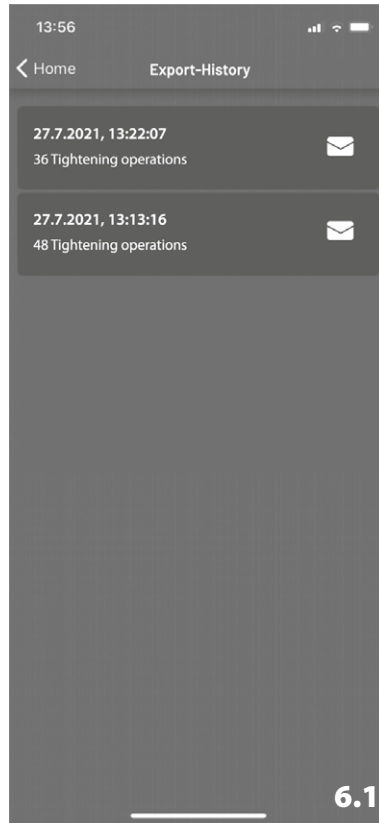
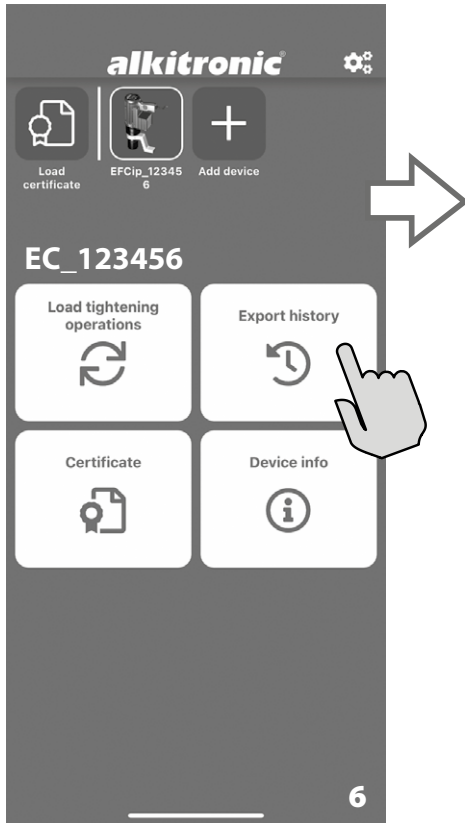

Display of the *alkitronic*[®] torque multiplier - specific properties (screen 7.1).





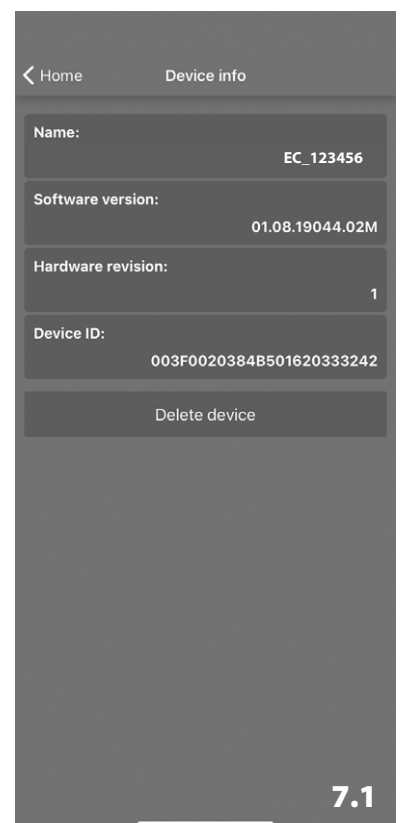
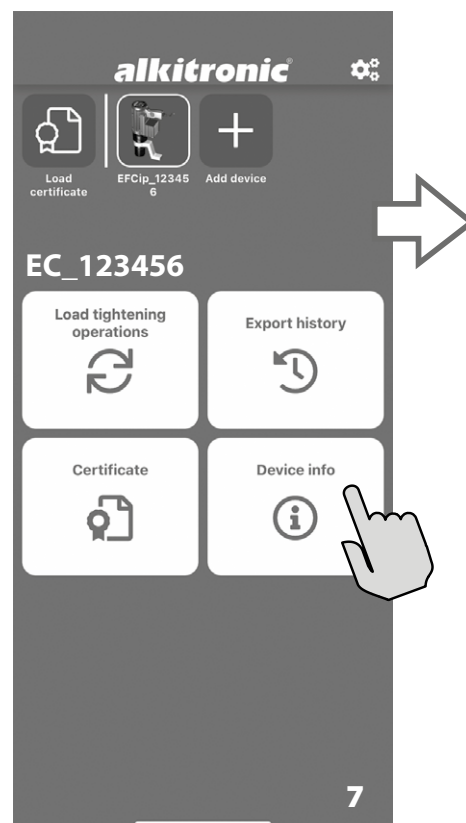
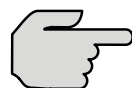

Calibration certificate

With this function, the *alkitronic*[®] EC-specific certificate can be transferred to the smartphone (as a supplement for the bolted joint documentation). As soon as the button is pressed, the camera function opens. This can be used to scan the QR code of the *alkitronic*[®] EC or the supplied calibration certificate.



4.4.7 Error messages in the EC operating area

Error messages are always displayed flashing and inversely.

	<p>General error Message Error message as hexadecimal figure</p>	 <p>Errors can be reset by using the “M” button, provided the cause is eliminated. If this fails, your alkitronic® partner will be pleased to help you. Please take a note of the error code and report it to our customer service.</p>
	<p>Error display electrical supply</p>	<p>Warning initiated due to faulty power/voltage supply or frequency. E.g. by undervoltage or overvoltage (<100 V or >253 V).</p>
	<p>General error display excessive temperature</p>	<p>Temperature errors cannot be reset using the “M” button. Resetting is done automatically when temperature thresholds fall again below the limit.</p> <p>To assure safe operation various temperature levels of the torque multiplier are controlled. A switch-off during a bolting process is however possible if the preset max. temperature limits are exceeded.</p>
	<p>TEMP-warning display „TEMP“ warning is flashing</p>	<p>Reactions</p>  <p>A - TEMP Error: The bolting process is blocked/cancelled.</p> <p>B - TEMP Warning during bolting: Finish the bolting process in progress.</p> <p>C - TEMP Warning prior to a bolting process: The bolting process is blocked until the temperature is back to normal. “TEMP” warning will then no longer show.</p>

4.4.8 General warnings

	 <p>Service warning IMPORTANT!</p>	 <p>IMPORTANT!</p> <p>Under excessive use/high loads or in case of many operation hours we recommend that calibration and service is carried out at shorter intervals than the recommended 12 months. In this case a service warning appears in the display. You can acknowledge the message with the “M” button. From this time on the information is shown at every restart of the torque multiplier.</p>  <p>Note additionally page 19, item 8.4 Maintenance intervals.</p>
---	--	---

Operation and Maintenance Manual

5. Mechanic Operation

5.1 Tightening and loosening

Safety hints



CAUTION!

Comply with all applicable local, state and national electrical and safety regulations.

Always carry out a function inspection and safety check - no working with damaged parts!

Keep your hair, clothing, and gloves away from moving parts. Loose clothes, jewellery or long hair can be caught in moving parts (*alkitronic*[®] *DMA/STACO/STABI/STA*).



DANGER!

Maintain a safety distance when tightening bolts or nuts. Do not leave the torque multiplier unattended during use. A rapid "switch off" in case of emergency must be always ensured.

Keep proper footing and balance at all times. This enables better control of the torque multiplier in unexpected situations.

5.1.1 Tightening and loosening - Models EC-S / EC-A

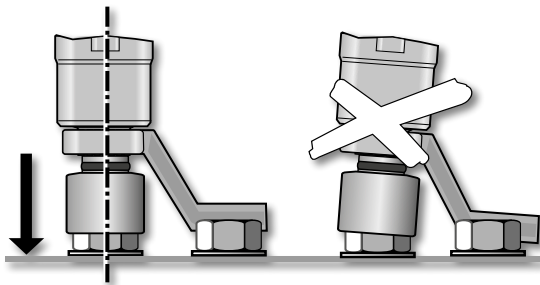

IMPORTANT!

Always place *STACO/STABI* completely on the bolt/nut. Provision of a safe and stable counter mounting is essential. For individual *DMA* solutions, your *alkitronic*[®] *Partner* will be pleased to assist you. In addition, non-compliance of any above items will void all warranty claims.



CAUTION!

Improper bolting connection or incorrect reaction support may cause:

- Strain breakage in *STACO / STABI* adaptors, bearing or output square drive;
- Bruises or even life-threatening injuries (parts splintering off);
- "Shut-off" torque failures.



DANGER!

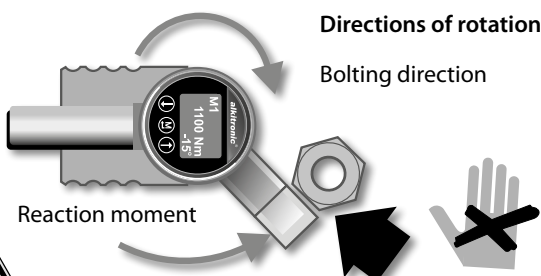

DANGER!

Never place your hand or fingers between the *DMA* and support point to avoid injuries by bruises!

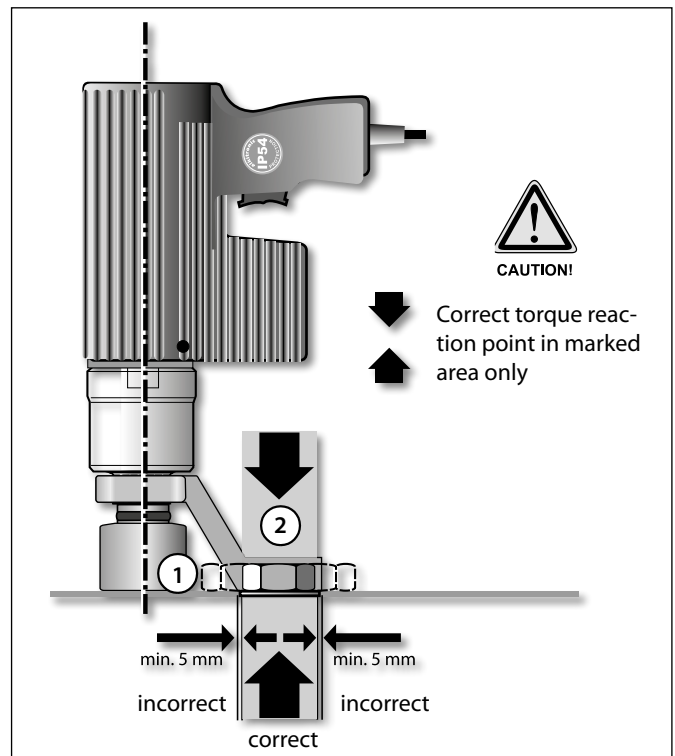

CAUTION!



Correct torque reaction point in marked area only

Operation steps *alkitronic*[®] *EC-S / EC-A*

- Connect the torque multiplier to the power supply.
- Place the *alkitronic*[®] torque multiplier with *alkitronic*[®] *STACO/STABI* completely on bolt/nut.
- The *DMA* or torque-on recipient of the torque multiplier must be at the same height as the socket/adaptor to take the reaction moment.
- A sure, stable counter-mount (2) must be ensured.
- Always keep the torque multiplier in axis line to the bolt during bolting process.
- **Push power switch and start bolting process.** The drive stops when achieving the desired torque or value.
- **Switch off machine and place on next bolt/nut.**

If the automatic release function is not set and the torque multiplier is not removable of the bolted joint (torsional forces caused):

- Release the torque multiplier by changing the direction of rotation and **briefly** press the ccw button until the *DMA* (reaction arm) is free.
- **For Information:** When loosening the bolted connection, up to 20% higher torque (loosening torque) may be required.
- Switch off machine and place *EC* multiplier on next bolt/nut and start bolting process.

Active automatic release function

This function enables a fast, secure "run free" of the *DMA* and also relieves torsional stresses within the multiplier.



IMPORTANT!

Application release function: This is not intended for loosening a bolt/nut. Use the automatic release function only to release tension inside the *EC* multiplier.

• End of the bolting process

If the bolting process was error-free („OK“ - shown in the display), confirm (↔) resp. the acknowledgment is automatically.

- Switch off machine and remove the *EC* torque multiplier, another bolting process can be started.



CAUTION!

Do not retighten the nut/bolt.
Because the preset torque is exceeded and it can lead to damage to the torque multiplier or to the bolt / threaded bolt.

5.1.2 Tightening and loosening models *EC-R* / *EC-SG*



NOTE!

The output drive of the *alkitronic*® *EC-R* and/or *EC-SG* takes place via a fixed width across flat (AF). For the reduction to smaller spanner openings an *alkitronic*® *STA* (3) is necessary. For proper operating use *alkitronic*® accessories only!



DANGER!

When using *alkitronic*® *EC-R* models the reaction pin (4) must be put completely into the receiving device. Otherwise there is a danger of case breakage and a risk of serious personal injury.

alkitronic® *EC-R* Models

alkitronic® *EC-SG* Models

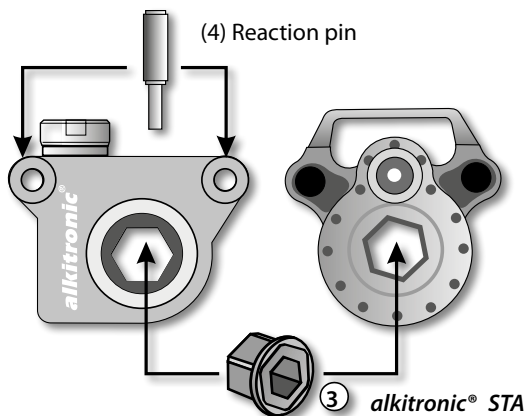

alkitronic® torque multiplier with radial gearing

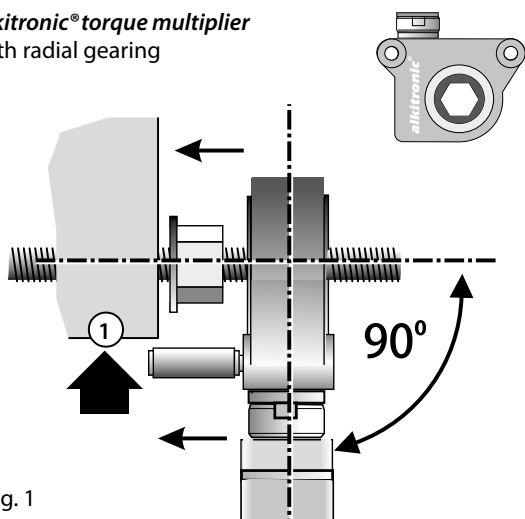

Fig. 1

alkitronic® electric torque multiplier with tangential gearing

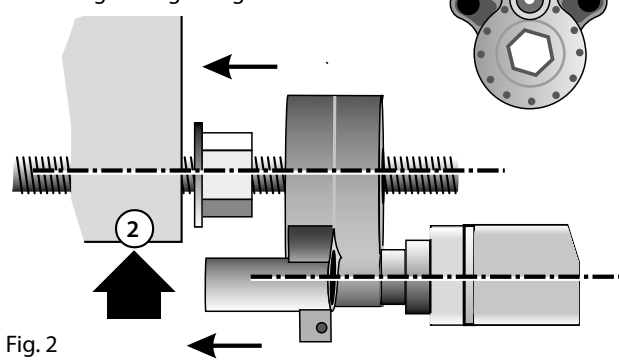

Fig. 2

Operating steps models *EC-R* / *EC-SG*

- Always place *alkitronic*® *EC-R* / *EC-SG* completely on the bolt/nut.
- A sure, stable counter-mount (Fig. 1/1)/(Fig. 2/2) must be ensured.
- Always note during the bolting process:
 - keep the *alkitronic*® *EC-R* multiplier in a 90 degrees angle to the bolt (Fig. 1).
 - keep the *alkitronic*® *EC-SG* multiplier in parallel line to the bolt (Fig. 2).
- Push power switch and start bolting process.
- The drive stops when achieving the desired torque or value.
- Switch off machine and place on next bolt/nut.

If the automatic release function is not set and the torque multiplier is not removable of the bolted joint (torsional forces caused):

- Release the torque multiplier by changing the direction of rotation and **briefly** press the ccw button until the *DMA* (reaction arm) is free.
- **For Information:**
When loosening the bolted connection, up to 20% higher torque (loosening torque) may be required.
- **End of the bolting process**
If the bolting process was error-free („OK“ - shown in the display), confirm (↔) resp. the acknowledgment is automatically.
- Switch off machine and place *EC* multiplier on next bolt/nut and start bolting process.



See also operation steps
alkitronic® *EC-S* / *EC-A* (page 16)



CAUTION!

Do not retighten the nut/bolt.
Because the preset torque is exceeded and it can lead to damage to the torque multiplier or to the bolt / threaded bolt.

Operation and Maintenance Manual

Safety tips while pulling together plate packages in heat exchangers:



Do not reach between end frame and reaction pin or gearing box (Fig. 3). Grasp torque multiplier only at the handle. In case of non-observance of above serious personal injuries can occur (e.g. bruises).

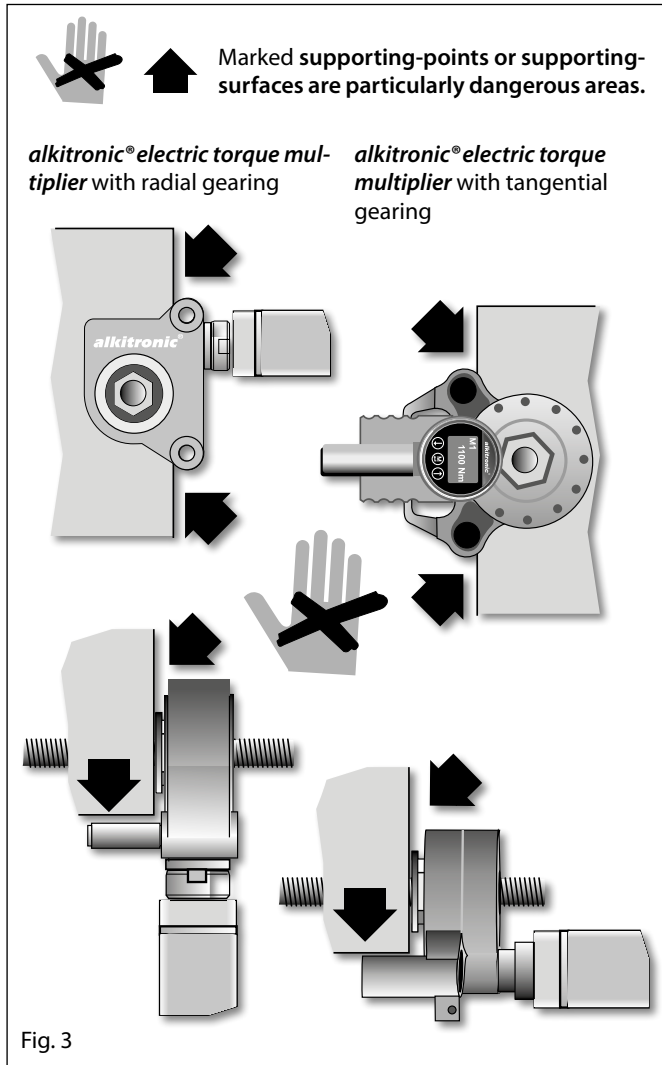

Fig. 3

6. Ending or Interrupting the Work

Alkitronic® electric torque multiplier



- Switch off and disconnect the cord plug from the power socket.
- Do not abuse the power cord. Never use the cord for carrying, pulling or unplugging the tool. Keep cord away from heat, oil, sharp edges or moving parts. Damaged or entangled cords increase the risk of electric shock.
- Place the torque multiplier on a flat and dry surface, avoid soiling and/or blockage of the ventilating openings (models without IP54 only).



7. Functional and Operational Tests

7.1 Optical and mechanical inspection



Check for intactness regularly, power cord and plug, display and operating elements, gear box, drive element, housing and accessories (e.g. reaction absorber *DMA*, adaptors). Before further use of the torque multiplier, damaged parts should be properly repaired or replaced. Serious damages and many accidents are caused by poorly inspected tools.



Keep free ventilating openings on the torque multiplier. This measure will reduce the risk of malfunctions, electronics and motor damage.



In cases of performance loss, strong gear noises or recognisable heavy damages a repair is to be carried out immediately. In the event of repairs the *Alkitronic® torque multiplier* (in original package) must be sent to the appropriate *Alkitronic® Partner* or directly to *alki Technik GmbH*.

The following operation and service requests should be strictly observed!

8. Service / Storing / Maintenance

8.1 Accessories change

Note item "3.2 Preparing for bolting" and carry out the described steps in reverse order.

8.2 Storage

The torque multiplier should be stored dry, cooled down and dust-free in *Alkitronic* original packaging

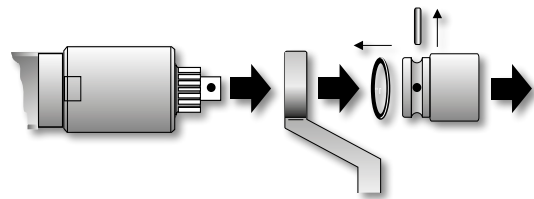

or in other lockable containers. Warmth and humidity may lead to oxidations in gear parts as well as in other parts within the tool housing. Take care that the power cord is neither clamped nor entangled and damaged in other manner. Following these rules will reduce the risk of malfunctions, electronics and motor damage.

8.3. Taking out of operation

In case that the *Alkitronic® electric torque multiplier* is stored for a prolonged period of time: Store the tool cleaned in a closeable dry room, out of the reach of children. Avoid excessive exposure to heat and moisture. Moving/rotating tool parts are to be preserved against Oxidation.

Note additionally item 8.2 Storage

8.4 Maintenance intervals



The *alkitronic® electric torque multiplier* is an extremely efficient and robust product. Nevertheless to ensure lifetime and performance for years, a regular maintenance is necessary (**Performance-Check, Motor-Check, Safety-Check, Calibration-Service**).

Maintenance periode / Service



The torque multiplier must be submitted at least once a year for inspection.

After high stresses/loads or also hours of operation a calibration and servicing must be carried out in

shorter periods. In this case a service warning appears in the display to remind the user. Acknowledge the message with the "M" button. From this time

on the information is shown at every restart of the torque multiplier.

SERVICE



In addition to the number of operating hours, the number of bolted joints is also a major factor in the use of the *alkitronic®* calibration service.

The table shows a type-specific number of bolted joints from which an inspection is to be carried out.

<i>alkitronic®</i> Type	Bolted Joints	Square (output)
EC-S 10 / 20 / 30 / 35	15 000	3/4"
EC-S 40 / 50 / 60 / 65 / 70	10 000	1"
EC-S 70 / 80	8 000	1 1/2"
EC-S 90 / 100	6 000	1 1/2"
EC-A 40 / 50 / 60 / 65 / 70	10 000	1"
EC-A 70 / 80	8 000	1 1/2"
EC-A 90 / 100	6 000	1 1/2"



Upon unusual gear or bearing noises, a lubrication of the transmission parts is urgently recommended in order to exclude consequential damage.

In the event of repairs the *alkitronic® torque multiplier* must be sent to the appropriate *alkitronic® Partner* or directly to *alki Technik GmbH* in original package.

9. Technical Notes



Notes regarding the operation of mobile generators:

For proper operation it must be ensured that the power output of a mobile generator is at least in accordance with the power input of the *alkitronic® torque multiplier*.

We recommend the use of regulated Mobile Generators.

Power output min. 1.5 kW upon operation of one *alkitronic® torque multiplier*.

Automatic or Inverter Regulations deliver a constant output voltage as well as a constant output current regardless of voltage drops, any spikes, the load or heavy load fluctuations.

Operating multiple appliances at one mobile generator at the same time the power consumption of all appliances must be considered!



Unregulated output voltage impairs operation and may damage the electronics of the *alkitronic® torque multiplier* extensively or even cause the equipment to shut down. Besides, in case of damage, warranty claims are at risk. Consistent power output without spikes is extremely important for safety in operation.

10. Acoustic Emission and Vibration

Sound pressure levels were measured for different work cycles, with the sensor positioned at a distance of 1 m to the geometric centre of the machine.

Sound pressure level at max. idling speed:

Models *EC-S / EC-A*: 68 - 72 dB(A).

Vibration:

becomes moderate just prior to reaching the pre-set torque.

11. Declaration of Conformity

On our own responsibility hereby declares *alki Technik GmbH* that the *alkitronic® electric torque multipliers* identified by Type EC-S, EC-A, EC-R, EC-SG and Serial number (e.g. YOM* 2021: 122.... or YOM* 2022: 222....), meet all relevant requirements of directives



2006/42/EG, 2011/65/EU, 2014/30/EU, 2014/35/EU, 2014/53/EU and Norms

DIN EN ISO 13849-1:2016-06, DIN EN ISO 12100:2011-03, DIN EN ISO 13849-2:2013-02, DIN EN 61000-6-2:2016-05, DIN EN 61000-6-4:2011-09, DIN EN 50581:2013-02, DIN EN 60204-1:2007-06, ETSI EN 301 489-1 (V.1.9.2), ETSI EN 301 489-17 (V.2.2.1), DIN EN 61800-5-1:2017-11, DIN EN 60034-1:2011-02, DIN EN 60034-5:2007-09, DIN VDE 0100-600:2017-06, DIN EN 62841-1:2016-07, DIN EN 62841-2-2:2015-05, ETSI EN 300 328.

2022-03-01

Alexander Kipfelsberger,
Managing director

Techn. documents at *alki Technik GmbH*, Unterlettenweg 4, 85051 Ingolstadt / Germany.

*) YOM Year of Manufacture

12. Appendix

- Technical info, Replacement of Power Cord Plug
- Technical data
- Additional Safety Instructions

TECHNICAL DIRECTIONS

Electric Torque Multipliers

Replacing the power cord plug



CAUTION!

Replacement of the power cord plug may only be performed by authorised personnel or a qualified electrician. Make sure the power cord is not connected to any power source before cutting off the power plug.

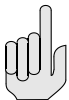

IMPORTANT!

All **alkitronic**® Electric Torque Multipliers are delivered with a three-wired power cord with ground conductor. The housing or metal parts are earthed by the PE.

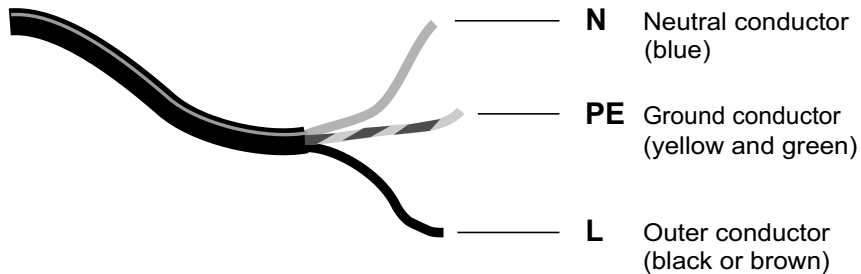

DANGER!

For avoidance of electric shocks or malfunctions check the multiplier for electric safety after the power plug change.



CAUTION!

Additional prerequisites for electric safety:

- Use only wall outlets with a protective earth connection (PE)!
- Make sure that the PE contact in the power socket is grounded!
- Use only a cord extension with an equipped ground conductor!



DANGER!

Incorrect connections of the supply line or outlet may lead to electric shocks with deadly injuries.

alkitronic® electric torque multipliers

Technical Data

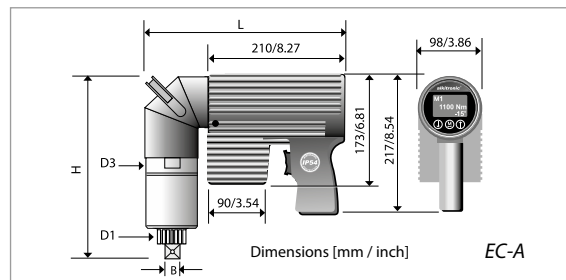
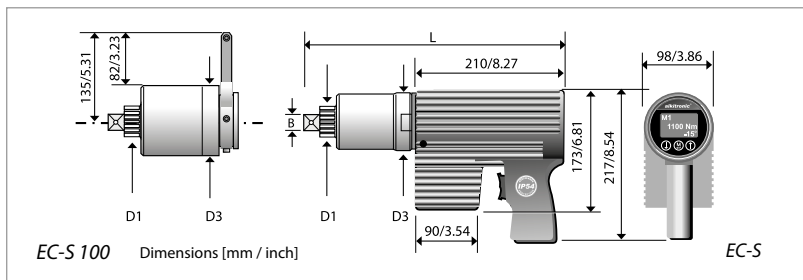

Models <i>alkitronic</i> ® EC-S	EC-S 10	EC-S 20	EC-S 30	EC-S 35	EC-S 40	EC-S 50	EC-S 60	EC-S 65	EC-S 70	EC-S 80	EC-S 90	EC-S 100
Torque range (approx.)* Nm	70-420	80-680	100-940	150-1300	150-1590	190-1870	250-2340	290-2930	350-3470	440-4400	500-5300	650-6530
ft.lbs	55-285	80-540	75-675	110-920	110-1190	140-1340	185-1725	215-2135	260-2540	325-3205	370-3730	480-4800
Square drive	B	3/4"	3/4"	3/4"	3/4"	1"	1"	1"	1"	1 1/2"	1 1/2"	1 1/2"
Diameter (approx.)	D ₁ mm / in	41/1.61	41/1.61	41/1.61	41/1.61	54/2.13	54/2.13	54/2.13	54/2.13	72/2.83	72/2.83	72/2.83
Diameter (approx.)	D ₃ mm / in	88/3.46	88/3.46	88/3.46	88/3.46	88/3.46	88/3.46	88/3.46	88/3.46	98/3.86	98/3.86	109/4.29
Length (approx.)	L mm / in	330/13.00	330/13.00	330/13.00	352/13.86	382/15.04	382/15.04	388/15.28	388/15.28	406/15.98	406/15.98	430/16.93
Weight w/o DMA** (appr.)	kg / lbs	9/19.84	9/19.84	9/19.84	9/19.84	10/22.05	10/22.05	11/24.25	11/24.25	13/28.66	13/28.66	15.5/34.17
Idle speed	rpm	70	40	30	22	15	14	11	8	7	5	4

Models <i>alkitronic</i> ® EC-A	EC-A 50	EC-A 60	EC-A 65	EC-A 70	EC-A 80	EC-A 90	EC-A 100
Torque range (approx.)* Nm	190-1870	250-2340	290-2930	350-3470	440-4400	500-5300	650-6530
ft.lbs	140-1340	185-1725	215-2135	260-2540	325-3205	370-3730	480-4800
Square drive	B	1"	1"	1"	1 1/2"	1 1/2"	1 1/2"
Diameter (approx.)	D ₁ mm / in	54/2.13	54/2.13	54/2.13	72/2.83	72/2.83	72/2.83
Diameter (approx.)	D ₃ mm / in	88/3.46	88/3.46	88/3.46	98/3.86	98/3.86	109/4.29
Length (approx.)	L mm / in	310/12.20	310/12.20	310/12.20	318/12.52	318/12.52	326/12.83
Height (approx.)	H mm / in	300/11.81	305/12.01	305/12.01	315/12.40	315/12.40	345/13.58
Weight w/o DMA (approx.)** kg / lbs	14/30.86	14/30.86	14/30.86	16/35.27	16/35.27	17/37.48	18/39.68
Idle speed (approx.)	rpm	14	11	8	7	5	4

*) When loosening a bolted connection, up to 20% higher torque may be required (loosening torque). We will gladly advise you in detail. ** Torque reaction arm.

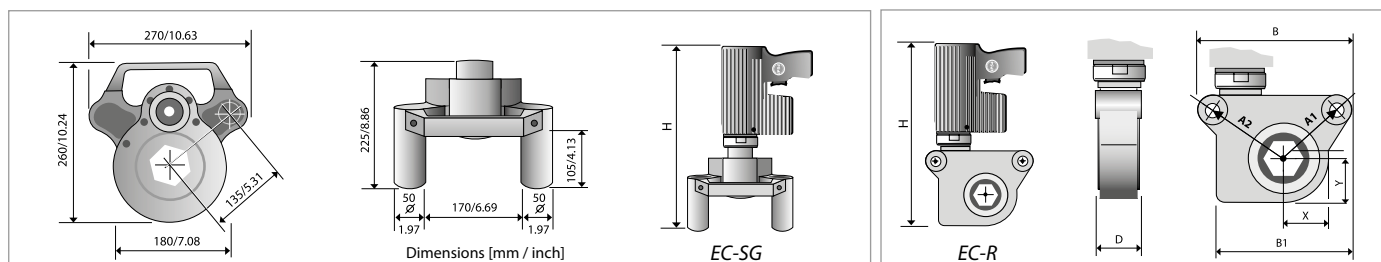

Models	Tangential Gear (SG)		Radial Gear (R)	
	EC-SG		EC-R	
Type	EC-SG 80		EC-R 46	EC-R 80
Torque range (approx.)* Nm	560-3780		250-2530	480-3840
ft.lbs	410-2790		185-1865	355-2825
Spanner width	mm / in		46/1.81	80/3.15
Height (approx.) H	mm / in		425/16.73	475/18.70
Width (approx.) B B1	mm / in		252/215 9.92/8.46	325/240 12.80/9.45
Bolt distance (approx.) A1 A2	mm / in		112/145 4.40/5.71	156/194 6.14/7.64
Dimensions (approx.) X Y	mm / in		75/75 2.95/2.95	98/98 3.86/3.86
Dimensions (approx.) D	mm / in		94/3.7	94/3.7
Weight (approx.)	kg / lbs		14.5/31.98	21/46.30
Idle speed (approx.)	rpm		10	9.5

Additional Safety Instructions

according to DIN EN 62841-1 (VDE 0740-1):2016-07,
EN 62841-1:2015 + AC:2015

The term „power tool“ used in the safety instructions refers to mains-operated power tools (with power cord) or battery-driven power tools (without power cord).

1. Workplace safety

- a) **Keep your working area clean and well lighted.**
Disorder or unlighted working areas can lead to accidents.
- b) **Do not work with the power tool in explosive atmospheres where flammable liquids, gases or dusts are present.**
Power tools produce sparks that can ignite the dust or fumes.
- c) **Keep children and other persons away while using the power tool.**
You may lose control of the power tool if distracted.

2. Electrical safety

- a) **The power tool's connector plug must fit into the socket. Do not modify the plug in any way. Do not use adapter plugs together with protective grounded power tools.**
Unmodified plugs and matching sockets reduce the risk of electric shock.
- b) **Avoid physical contact with grounded surfaces such as pipes, heaters, stoves, and refrigerators.**
There is an increased risk from electric shock if your body is grounded.
- c) **Keep power tools away from rain or wet conditions.**
Water getting into a power tool increases the risk of electric shock.
- d) **Do not misuse the power cord to carry, hang or unplug the power tool. Keep the power cord away from heat, oil, sharp edges or moving parts.**
Damaged or tangled power cords increase the risk of electric shock.
- e) **When working outdoors with a power tool, use only extension cords that are suitable for outdoor use.**
Using an extension cord suitable for outdoor use reduces the risk of electric shock.
- f) **If operation of the power tool in a damp environment cannot be avoided, use a residual current device (RCD).**
The use of a residual current device (RCD) reduces the risk of electric shock.

3. Safety of persons

- a) **Be alert, pay attention to what you are doing, and use common sense when working with a power tool. Do not use a power tool when you are tired or under the influence of drugs, alcohol or medication.**
A moment of carelessness while using a power tool can result in serious injury.
- b) **Wear personal protective equipment and always safety glasses.**
Wearing personal protective equipment, such as dust mask, non-slip safety shoes, safety helmet or hearing protection, depending on the type and use of the power tool, reduces the risk of injury.
- c) **Avoid unintentional start-up. Make sure the power tool is switched off before connecting it to the power supply and/or battery, picking it up or carrying it.**
If you have your finger on the switch while carrying the power tool or connect the power tool to the power supply while it is switched on, this can lead to accidents.
- d) **Remove adjustment tools or wrenches before turning on the power tool.**
A tool or wrench that is in a rotating part of the power tool can cause injury.
- e) **Avoid abnormal posture. Ensure that you stand securely and maintain your balance at all times.**
This will help you control the power tool in unexpected situations.
- f) **Wear appropriate clothing. Do not wear loose clothing or jewelry. Keep hair and clothing away from moving parts.**
Loose clothing, jewelry or long hair can be caught by moving parts.
- g) **If dust extraction and dust collection equipment can be fitted, it must be connected and used correctly.**
Use of a dust extraction system can reduce hazards from dust.
- h) **Do not lull yourself into a false sense of security and do not ignore the safety rules for power tools, even if you are familiar with the power tool after using it many times.**
Careless actions can lead to serious injuries within fractions of a second.

4. Use and handling of the power tool

- a) **Do not overload the power tool. Use the power tool intended for your work.**
With the appropriate power tool, you will work better and safer in the specified power range.
- b) **Do not use a power tool whose switch is defective.**
A power tool that cannot be switched on or off is dangerous and must be repaired.
- c) **Unplug the power tool and/or remove a removable battery before making any equipment adjustments, changing insert tool parts, or putting the power tool away.**
This precaution prevents unintentional starting of the power tool.
- d) **Keep unused power tools out of the reach of children. Do not allow anyone to use the power tool who is unfamiliar with it or has not read these instructions.**
Power tools are dangerous when used by inexperienced persons.
- e) **Take care of power tools and application tools. Check that moving parts are working properly and are not jammed, that parts are not broken or damaged in such a way that the function of the power tool is impaired. Have damaged parts repaired before using the power tool.**
Many accidents are caused by poorly maintained power tools.
- f) **Keep cutting tools sharp and clean.**
Carefully maintained cutting tools with sharp cutting edges jam less and are easier to guide.
- g) **Use power tools, insert tools, etc. according to these instructions. Take into account the working conditions and the activity to be performed.**
The use of power tools for applications other than those for which they are intended can lead to dangerous situations.
- h) **Keep handles and grip surfaces dry, clean and free of oil and grease.**
Slippery handles and grip surfaces do not allow safe operation and control of the power tool in unforeseen situations.

5. Service

- a) **Only repair your power tool by qualified personnel and only with original spare parts.**
This will ensure that the safety of the power tool is maintained.

YOUR PLUS FOR MORE PERFORMANCE

Increased quality

Premium production
Highest quality materials
Long product life cycles
Since 1984 experience in bolting technology
Made in Germany – international patents

Increased precision

Precise, customer-specific torques
High repeatability
Reliability in permanent operation
Documentation of tightening results
Automatic shut-off

Increased productivity

Quicker tightening without reworking
No environmentally caused failures (IP54, ATEX)
High work safety
Easy to use: clear, simple instructions
Low maintenance and cost efficient

Better service

Technical advice on site
Training offers
Manufacturer's calibration and certification
Lifecycle support
Spare part and repair service

alki TECHNIK GmbH

Development, Production and Distribution of Bolting Systems

Unterlettenweg 4 – 85051 Ingolstadt/Germany – fon +49 841 97499-0 – fax +49 841 97499-90
info@alkitronic.com – www.alkitronic.com

EXTRACT FROM OUR PRODUCT RANGE

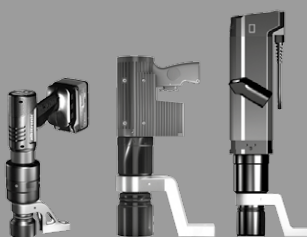

alkitronic XE-SERIES

THE ELECTRICS

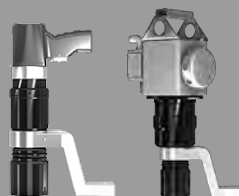

alkitronic XP-SERIES

THE PNEUMATICS

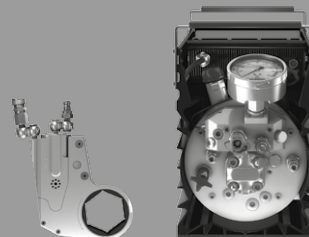

alkitronic XH-SERIES

THE HYDRAULICS



alkitronic XM-SERIES

THE MANUALS