



EB-S

Battery driven
torque multiplier



reddot winner 2023



DESIGN
AWARD
2023

The new EB – Extreme Flexibility

Applications

- **alkitronic® EB:** Battery-driven torque multiplier from 110 Nm to 6,000 Nm / 90 ft.lbs to 4,420 ft.lbs.
- **Extremely mobile and always ready for use:** Innovative product design for comfortable working - independent of external power supply.

Advantages

- **High quality materials:** Robust aluminium profile housing for compact and safe mounting of electric motor and primary gear unit. Excellent heat dissipation over large surfaces and airflow cooling system.
- **Maximum flexibility:** Thanks to the application-specific, modular software packages e.g.:
 - bolting according to the torque/rotation angle method,
 - can also be retrofitted later if the bolting application changes.
 - *alkitronic® Smart Service* - Documentation of the bolted joints.
- **Ergonomic design:** Ultra grippy housing for your safety and a secure bolting procedure.
- **OLED-display:** Anti-glare and high contrast - for perfect reading under all weather conditions.
- **High quality bolting:** The brushless synchronous motor with excellent efficiency and the smart processor-controlled automatic shutdown ensures amazing increased productivity and **low running costs**.
- **Low noise emissions, no noise protection necessary.**
- **Unique 1-finger trigger:** Unbeatable efficiency through fast, simple change of direction of rotation.
- **Repeat shut-off accuracy $\pm 3\%$** for the same bolting application.

alkitronic® specials

- **Simple navigation:** Intuitive interface drastically reduces operating errors and misadjustments.
- **Health and safety first:** Due to a new technology patented by *alkitronic®* the reaction torques are decoupled. This leads to an extreme reduction of radial forces on the wrist to 1 Nm and thus actively contributes to the occupational health and safety of the worker.
- **Outstanding battery concept:** Powerful and durable battery for precise, consistent bolting quality - worldwide shipping.



reddot winner 2023



Bolting programs

The software suite 1 is pre-installed in the basic equipment. For user-specific applications, the manufacturer can activate optional modular software:

Software suite 1: Torque controlled bolting (standard)

Software suite 2: Torque/angle procedure for high-quality bolting connections

Software suite 2

Premium: Torque/angle procedure with adjustable min./max. torque limitation

Software suite 3: Bolting with **preset rotations** and **torque limit**

Software suite 5: Bluetooth transfer via *alkitronic® APP*.

Documentation of the bolted joints (target-actual status, recording for each joint)

Specifications

All *alkitronic® EB* torque multipliers with CE-certification.

Caution! The Li-Ion battery is preset to 4 Ah (72 Wh) so that it can be shipped or transported in accordance with special regulation 188.

Operating panel

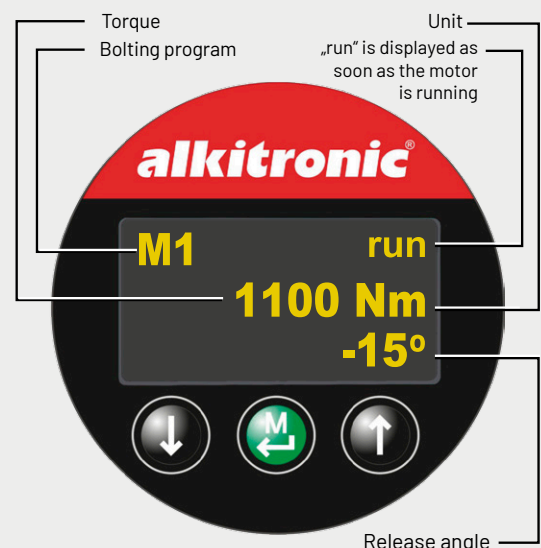

Technical Data

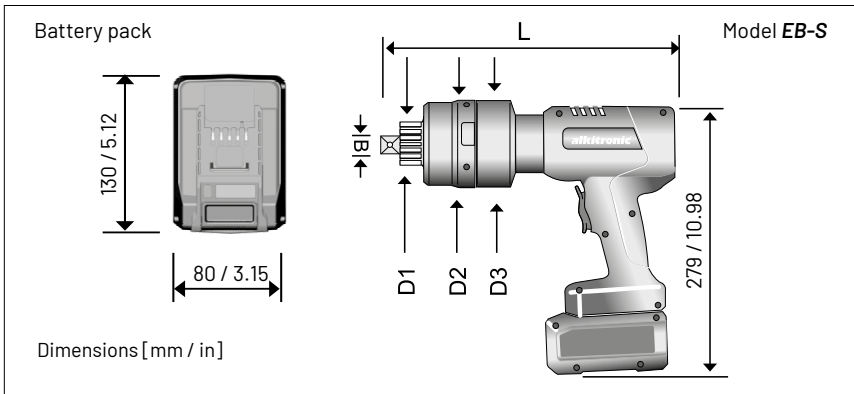

alkitronic® DMA

Topology-optimised construction: very light and yet stable.



Models EB-S

Type		EB-S 80	EB-S 150	EB-S 180	EB-S 250	EB-S 350	EB-S 400	EB-S 480	EB-S 600
Torque ranges (approx.)*	Nm	110-850	150-1400	250-1800	350-2500	480-3500	560-4000	650-4800	800-6000
	ft.lbs	90-620	110-1030	190-1330	260-1840	360-2580	410-2950	480-3540	590-4420
Square drive	B	3/4"	3/4"	1"	1"	1"	1"	1 1/2"	1 1/2"
Diameter (approx.)	D ₁	41/1.61	41/1.61	54/2.13	54/2.13	54/2.13	54/2.13	72/2.83	72/2.83
Diameter (approx.)	D ₂	88/3.46	88/3.46	88/3.46	88/3.46	88/3.46	88/3.46	98/3.86	109/4.29
Diameter (approx.)	D ₃	88/3.46	88/3.46	88/3.46	88/3.46	88/3.46	88/3.46	88/3.46	88/3.46
Length (approx.)	L	330/13.00	330/13.00	375/14.76	382/15.04	382/15.04	382/15.04	400/15.75	407/16.02
Weight w/o DMA**, Battery (appr.)	kg / lbs	5.3/11.68	5.3/11.68	6.7/14.77	7.3/16.09	7.3/16.09	7.3/16.09	9.3/20.50	10.5/23.15

*) When loosening bolts, a higher torque (up to 50 %) may be necessary (release torque). **) Torque reaction arm. We will be pleased to help you with your choice.



Display views

Software suite 1 (mode 1) and software suite 2 (mode 2)

Mode 1 / M1 (Standard)

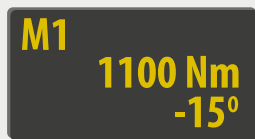

Bolting via torque.
Automatic release according to pre-set angle degrees.

Mode 2 / M2 (Option)

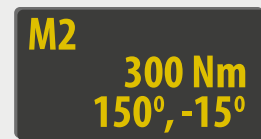

Torque/angle procedure for high-quality bolting connections.
Display example of pre-torque, angle and release angle.

During the bolting process, the current torque value is shown in the display. Reaching the set value is indicated by an "OK". If the selected value cannot be achieved, the bolting operation is evaluated as "nOK".

Scheme bolting programs Mode 1 und Mode 2

Torque controlled bolting mode 1

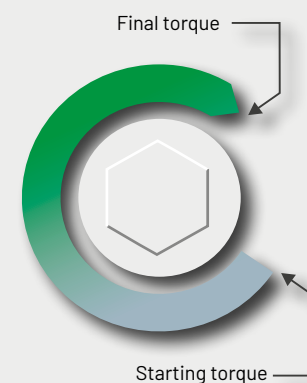

Torque/angle procedure mode 2

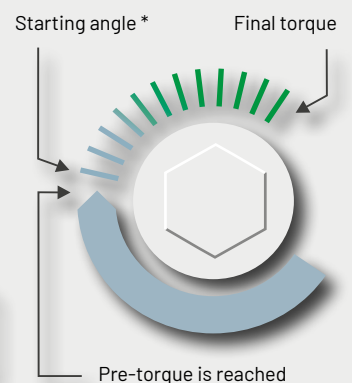

* Information on rotational angle setting for torque/angle method.

- The angle of rotation is specified by the design for the bolting connection.
- The angle of rotation can be determined individually and easily with alkitronic® M-SD. We will gladly provide you with detailed product information.

YOUR PLUS FOR MORE PERFORMANCE

Increased quality

- Premium production
- Highest quality materials
- Long product life cycles
- Experience in bolting technology since 1984
- Made in Germany – international patents

Increased precision

- Precise, customer-specific torques
- High repeatability
- Reliability in permanent operation
- Documentation of tightening results
- Automatic shut-off

Increased productivity

- Quicker tightening without reworking
- No environmentally caused failures (IP54, ATEX)
- High work safety
- Easy to use: clear, simple instructions
- Low maintenance and cost efficient

Better service

- Technical advice on site
- Training offers
- Manufacturer's calibration and certification
- Lifecycle support
- Spare part and repair service

alki TECHNIK GmbH

Development, Production and Distribution of Bolting Systems

Unterlettenweg 4 – 85051 Ingolstadt/Germany – fon +49 841 97499-0 – fax +49 841 97499-90
info@alkitronic.com – www.alkitronic.com

EXTRACT FROM OUR PRODUCT RANGE



alkitronic XE-SERIES

THE ELECTRICS



alkitronic XP-SERIES

THE PNEUMATICS

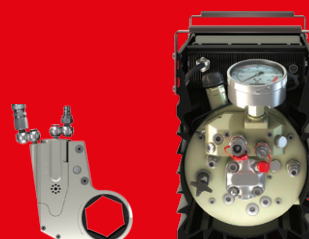

alkitronic XH-SERIES

THE HYDRAULICS



alkitronic XM-SERIES

THE MANUALS