



# EB-S

## Operation and Maintenance Manual

Battery driven torque multiplier  
Series EB



reddot winner 2023



DESIGN  
AWARD  
2023

# Operation and Maintenance Manual

## Foreword

Congratulations on your purchase of an *alkitronic® EB-S Battery driven torque multiplier*. This high quality product sets unique international standards and satisfies high safety levels. In order to preserve these features, your assistance by regular maintenance is required. Please read this operation and maintenance manual carefully and observe the following information and instructions:

Maintenance and repair of the *alkitronic® EB-S* must be performed by the alki TECHNIK GmbH or certified workshops adequately trained and instructed by alki TECHNIK GmbH.

Improper maintenance may endanger your health and damage the unit. In addition, non-compliance of any above items will void all warranty claims!

This operation and maintenance manual includes basic information and instructions which must be observed during operation and maintenance. The operator must read and understand the basic precautions before operation or performing maintenance. It must always be available on site.

This operation and maintenance manual applies only to the *alkitronic® EB-S*.

Do not only observe the "Safety instructions" mentioned in "Definition of symbols", but also all other special instructions and hints in other sections.

## Definition of Symbols



Safety instructions, which by non-compliance may result in personal injury or death.



Safety instructions, which by non-compliance may result in damage to the *alkitronic® EB-S*, its functions or the environment.



IMPORTANT! Information for proper and safe operation.



NOTE! Practical advice and information to make work easier.

## Content Table

	Page
<b>A Reception Control and Packaging</b>	<b>3</b>
<b>B General Description</b>	<b>3</b>
<b>B1 Model Description</b>	<b>3</b>
<b>1. Safety Instructions</b>	<b>3</b>
1.1 Intended use	3
1.2 Operators responsibilities	3
1.3 Possible hazards warnings <i>alkitronic® EB-S</i> and charger	3
<b>2. Technical Data Battery and Charger</b>	<b>4</b>
<b>3. Start-up Li-Ion Battery</b>	<b>4</b>
3.1 Changing of the battery pack capacities	4
3.2 Hazard warnings <i>alkitronic®</i> battery pack	4
3.3 Error codes display battery	5
<b>4. Operation Charging Station</b>	<b>5</b>
4.1 Charging the Li-Ion battery pack	5
4.2 Charger indicator explanations and actions	6
<b>5. Operations/ Settings <i>alkitronic® EB-S</i></b>	<b>7</b>
5.1 Left/right operation	7
5.2 Operating area with OLED-Display	7
5.3 Overview bolting programs (Modes)	7
5.4 Bolting programs	8
5.4.1 .....according to the torque method (standard)	8
5.4.2 .....according to the torque/angle method	9
5.4.3 .....according to the torque/angle method - Premium	10
5.4.4 Bolting with specification of turns	11
5.4.5 Documentation bolted joint and Bluetooth activation	12
5.4.6 The <i>alkitronic® APP</i>	13
5.4.7 Error messages in the <i>alkitronic® EB-S</i> operating area	16
<b>6. Mechanic Operation <i>alkitronic® EB-S</i></b>	<b>17</b>
6.1 Placing tool in operation	17
6.2 Preparing for bolting	17
6.3 Safety instructions operation	18
6.3.1 Tightening and loosening	18
<b>7. End of Work / Interruption / Cleaning</b>	<b>19</b>
<b>8. Functional and Operational Tests</b>	<b>19</b>
8.1 Optical and mechanical inspection	19
<b>9. Storage / Maintenance / Service</b>	<b>20</b>
9.1 Accessories change	20
9.2 Storage	20
9.3 Taking out of operation	20
9.4 Maintenance intervals	20
<b>10. Technical Notes</b>	<b>20</b>
<b>11. Acoustic Emission and Vibration</b>	<b>20</b>
<b>12. Environmental Protection</b>	<b>20</b>
<b>13. Conformity Declaration</b>	<b>21</b>
<b>14. Technical Data</b>	<b>21</b>
<b>15. Additional Safety Instructions</b>	<b>22</b>

# alkitronic® EB-S Battery driven Torque Multiplier

## A Reception Control and Packaging



All parts must be visually inspected for any transport damage. If such damage is found, notify the carrier or the **alkitronic® Partner** immediately. All returns only in original packaging, this will prevent damage to your **alkitronic®** tools/devices. Therefore, keep the packaging!

## B General Description

**alkitronic® EB-S Battery driven torque multiplier** are strength power-operated torque multipliers for continuously tightening or loosening heavy duty bolt connections.

The torque multiplier turns off with achievement of a demanded value or final torque.

The drive is done by a maintenance-free, low-wear synchronized motor without brushes and excellent efficiency, large torque range and high assembly speed.

### B 1 Model Description

**alkitronic® EB-S Battery driven torque multiplier** with axial drive. Comfortable 360° rotatable motor unit, robust motor housing made of an aluminium alloy in combination with impact-resistant plastic.

**alkitronic® EB-S** - torques up to 6,000 Nm\* / 4,420 ft.lbs\*.

Models with OLED-Display, menu guidance and bolting programmes as for example torque/angle procedure.

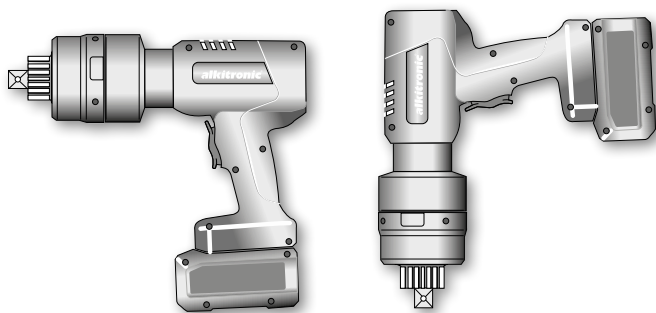

All models with overload protection.

\* approx. values / torque values are dependent on model



reddot winner 2023



## 1. Safety Instructions

### 1.1 Intended use

**alkitronic® EB-S** are designed to tighten or loosen heavy duty bolt connections continuously. Do not use the torque multiplier for any other purpose than its intended use. For other applications please consult alki TECHNIK GmbH.

### 1.2 Operators responsibilities

The operator must have read and understood the instructions of this operation and maintenance manual before using or servicing the **alkitronic® EB-S**. Minimum age of the operator must be 18 years.

Operation and service may not be performed, if the concerned person does not understand purpose, consequences and precise performance of each procedure. For questions regarding the safety measures and areas of application, your **alkitronic® Partner** will be pleased to assist.



Improper operation, incorrect application, abuse or use by unqualified personnel may be hazardous to other persons, operator, torque multiplier and other property.



The operator is responsible to third parties within the work area. Keep children and bystanders away while operating the torque multiplier.



Only use the **alkitronic® charging station** indoors! Protect the charging station from moisture!

Non-authorized alterations and modifications of the torque multiplier are not permitted.

### 1.3 Possible hazards **alkitronic® EB-S** and charging station



In the event of smoke or fire, immediately disconnect the battery pack and charger or put the device away in a safe place.

The torque multiplier and charging station must not be used in potentially explosive atmospheres. When used in any working environment, the relevant local regulations - as well as your own protective measures - must be observed.



In case of mechanical or electrical damage to the **alkitronic® EB-S** or the **alkitronic® charging station**, stop operation immediately.

The damaged device must be checked for mechanical or electrical safety. Repairs may only be carried out by authorised personnel. Defects must be rectified before further operation. Before starting repair work on mechanical and electrical parts, disconnect the power supply or remove the battery from the torque multiplier.

# Operation and Maintenance Manual

## 2. Technical Data Battery Pack and Charger

**alkitronic**®/Einhell **Li-Ion** battery pack  
18 V, 4 Ah or 6 Ah adjustable.  
Optimum storage temperature 5° - 30° C.

**alkitronic**®/Einhell **Charging station** 220-250 V / 50-60 Hz /  
max 95 W, output 20 V / 4,0 A (d.c.)



**Important!** According to special provision 188, the lithium-ion battery must always be set to 4 Ah (72 Wh) before it can be shipped or transported! Faulty lithium-ion batteries must never be shipped in the ordinary mail! Please contact alki TECHNIK GmbH or your **alkitronic**® partner.

## 3. Start-up Li-Ion Battery

### 3.1 Changing of the battery capacities

The **alkitronic**®/Einhell **Li-Ion** battery pack can be switched between two capacities (4 Ah/6 Ah)

- 4 Ah (72 Wh) --> better for the battery, extending its total life by about 3 times
- 6 Ah (108 Wh) --> long operating time per battery charge

The battery is supplied with 4 Ah (72 Wh).

**When bolting, we recommend using the battery pack with the preset of 4 Ah, as the performance of the **alkitronic**®EB-S is optimized for this setting. It is therefore not necessary to change to 6 Ah to achieve the maximum torques**



#### Advice

In order to further increase the number of bolted joints, **the charging of the battery pack can be carried out at a 6 Ah setting**, thus achieving a maximum state of charge. As soon as the charging process is finished, set the capacity back to 4 Ah!

### Proceed as follows for the settings:



**Important! Read the instructions through completely before changing the battery setting!**

- Hold the button (Fig. 1) for the battery charge level indicator (A) down for about 6 seconds until the battery on the display (B) begins to count from 1 to 9.
- To switch from 4 Ah to 6 Ah, press the button (A) briefly again when the number 6 is displayed. The count then continues as normal to 9.
- To switch from 6 Ah to 4 Ah, press the button (A) briefly again when the number 4 is displayed. The count then continues as normal to 9.
- Once the display (B) has reached 9, the new setting "6Ah" or "4Ah" will be indicated for about 2 seconds. The battery is now switched and ready for use.

- The battery can only be switched if the number 4 or 6 is pressed. Other numbers do not have any significance.

**This process is essential in order to avoid switching over inadvertently.**

### Battery charge level indicator

Press the battery charge level indicator button (A) briefly. The display (B) for the battery charge level indicator initially displays the charge status in % and then the current set charge level consecutively for 2 seconds each.



#### Important!

The charge status adjusts automatically after a switch to 4 Ah or 6 Ah and can differ from the previous setting. If the battery has a charge status of 100 % when set to 4.0 Ah, for instance, and is then switched to 6.0 Ah, the charge status will fall to significantly less than 100 %. You will need to recharge the battery.

### 3.2 Hazard warnings **alkitronic**® battery pack



Protect battery packs (1) from moisture and do not expose to fire!



DANGER!

Do not use defective or deformed battery packs! Do not open battery packs! Do not touch or short-circuit the contacts! Keep small metal objects away that could cause bridging of the contacts. A short circuit can cause fire and burns.



DANGER!

A slightly acidic, flammable liquid can escape from defective Li-Ion battery packs!



DANGER!

If battery fluid leaks out and comes into contact with your skin, rinse immediately with plenty of water. If battery fluid gets into your eyes, wash them out with clean water and seek medical attention immediately!



DANGER!

Never charge non-rechargeable batteries. Danger of explosion!  
Do not recharge a fully charged battery pack!



DANGER!

Do not insert any objects into the ventilation of the **alkitronic**®EB-S housing or the **charging station** - risk of short circuit or electric shock!



# alkitronic® EB-S Battery driven Torque Multiplier

## 3.3 Error codes display battery

Error Codes	Cause	Remedy
F01	The battery is too hot (e.g. due to direct sunlight)	Store it at room temperature (approx. 20° C) for one day
F02	The battery is too cold	Store it at room temperature (approx. 20° C) for oneday
F03	The battery is overloaded	Remove the battery from the equipment and try it again No change: see F01
F04	The battery is defective	<b>A defective battery is not allowed to be used any more</b>
F05	The battery is partially fully discharged	Recharge the battery

## 4. Operation Charging Station

### 4.1 Charging the Li-Ion battery pack

- Remove the battery pack (1) from the handle, pressing the pushlock button (2) downwards to do so (Fig. 2).
- Check that your mains voltage is the same as that marked on the rating plate of the battery charger.



Fig 2

- Insert the power plug of the charger into the mains socket outlet. The green LED will then begin to flash. Push the battery pack onto the battery charger (3).
- At page 6, item 4.2 (Charger indicator) you will find a table with an explanation of the LED indicator on the charger.
- If the battery pack fails to charge, check for the following:
  - **voltage at the power socket ?**
  - **whether there is good contact at the charging contacts of the charging unit ?**
- If charging of the battery pack is still not possible, please contact your **alkitronic® partner** or send the charging station and the battery pack to alki TECHNIK GmbH. Please contact your **alkitronic® partner** for professional shipping.

In the interest of a long service life of the battery pack, you should ensure that the battery pack is recharged in good time. This is necessary in any case if you notice that the performance of the device is decreasing. Never discharge the battery pack completely. This will lead to a defect in the battery pack!

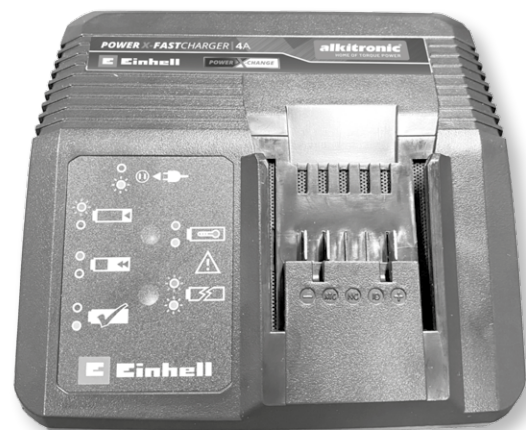

alkitronic®/Einhell Charging station

# Operation and Maintenance Manual

## 4.2 Charger indicator - explanations and actions

Indicator status			Explanations and actions
Pos.	LED red	LED green	
1	Off	Flash- ing	<b>Ready for use Ready for use</b> The charger is connected to the mains and is ready for use; there is no battery pack in the charger.
2	Flash- ing	Off	<b>Charging</b> The charger is charging the battery pack in quick charge mode. The charging times are shown directly on the charger. Important! The actual charging times may vary slightly from the stated charging times depending on the existing battery charge.
3	On	Off	<b>The battery is charged and ready for use. (READY TO GO)</b> The unit then changes over to gentle charging mode until the battery is fully charged. To do this, leave the rechargeable battery on the charger for approx. 15 minutes longer. <b>Action:</b> Take the battery pack out of the charger. Disconnect the charger from the mains supply.
4	Off	On	<b>Adapted charging</b> The charger is in gentle charging mode. For safety reasons the charging is performed less quickly and takes more time. <b>The reasons can be:</b> - The rechargeable battery has not been used for a very long time. - The battery temperature is outside the ideal range. <b>Action:</b> Wait for the charging to be completed; you can still continue to charge the battery pack.
5	Flash- ing	Flash- ing	<b>Fault</b> Charging is no longer possible. The battery pack is defective. <b>Action:</b> Never charge a defective battery pack. Take the battery pack out of the charger.
6	On	On	<b>Temperature fault</b> The battery pack is too hot (e.g. due to direct sunshine) or too cold (below 0° C). <b>Action:</b> Remove the battery pack and keep it at room temperature (approx. 20° C) for one day .

Positions Display status

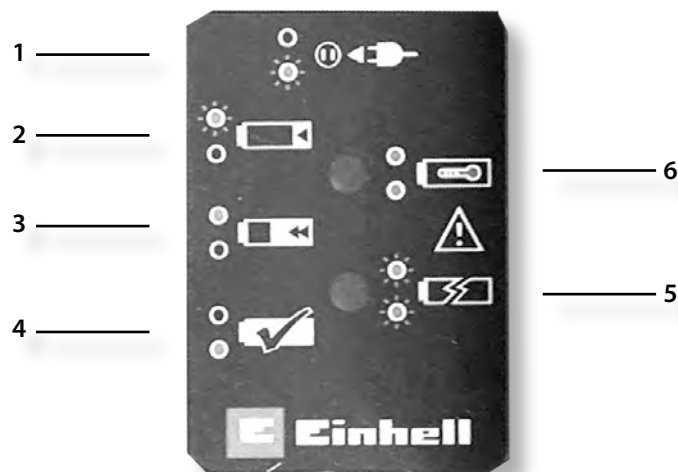

# alkitronic® EB-S Battery driven Torque Multiplier

## 5. Operations / Settings *alkitronic® EB-S*

### 5.1 Left/right operation

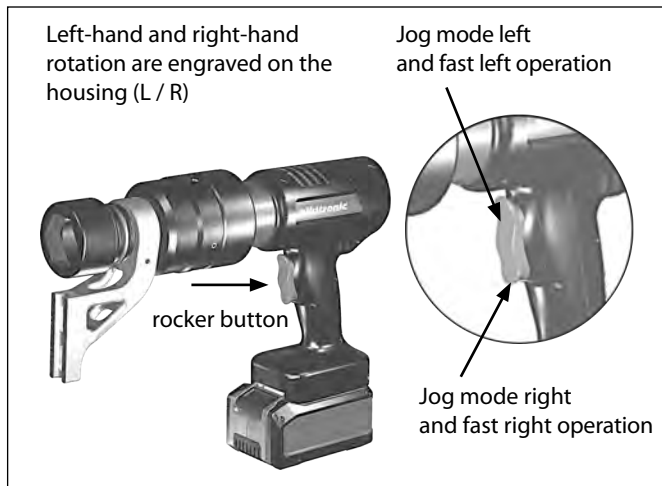

#### Bolting operation with the rocker button

##### Pressure point down (R):

Jog mode right and fast right-handed operation

##### Pressure point up (L):

Jog mode left and fast left-hand rotation

If the rocker is pressed down for a longer time, the *alkitronic® EB-S* switches to normal operation; when the rocker is released, the bolting process stops.

When the set final torque/value is reached, the *alkitronic® EB-S* switches off precisely.



Never block the rocker switch. Proper operation and safe working is no longer possible

### 5.2 Operating area with OLED display

#### Key-Symbols



Decrease value / line down



Mode selection / input confirmation



Increase value / line up

See Fig. 3, Operating area

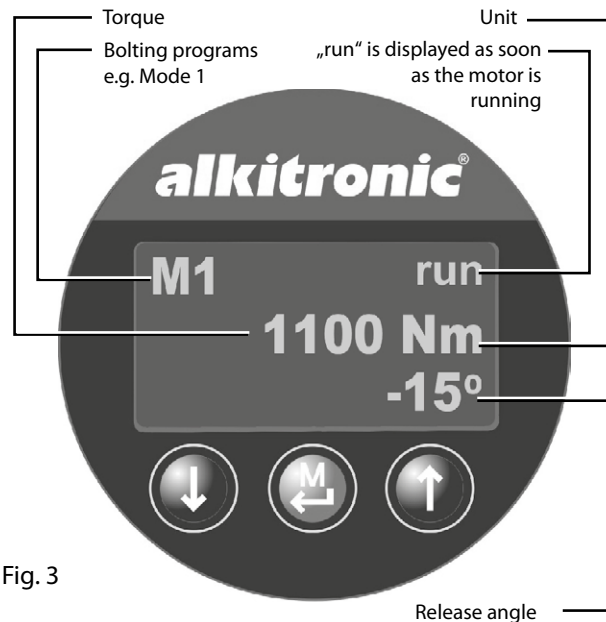

Fig. 3

### 5.3 Overview bolting programs (Modes)

Mode	Description
M 1	Bolting according to the torque method, automatic release with adjustable angle degrees.* Already included in the scope of delivery.
M 2	Bolting according to the torque/angle method, automatic release function with presettable angle degrees.*
M 2 Premium	Additional adjustable torque limits
M 3	Bolting with presetting of revolutions and adjustable torque limitation.
M 5	Documentation of the bolting operations (target/ actual status recording for each bolting operation performed). Bluetooth transfer via <i>alkitronic® APP</i> .



NOTE!

\* Caused by high torsional force it is often impossible repositioning the torque multiplier on the next screw joint. Therefore use the automatic release function to relieve stresses within the multiplier. The setting of angle degrees enables a "run free" of the reaction absorber *DMA*.

# Operation and Maintenance Manual

## 5.4 Bolting programs (standard)

### 5.4.1 Bolting according to the torque method

#### Settings mode 1 - with/without automatic release function

Start Screen



\* After a short time, the display jumps to the next image (example).

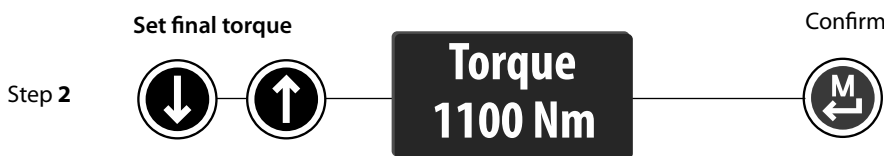

**NOTE!** The setting steps of the torque values are in increments of 10 Nm (10 ft.lbs).

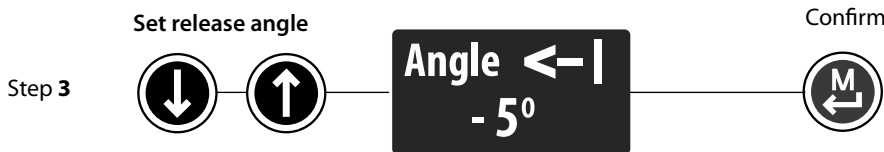

If no automatic release function is desired, set release angle to „0“.

**Note on the procedure for the loosening angle:** This is not intended for loosening a bolt/nut, here only the release of tension between the torque multiplier and the bolted joint is established!

Correction procedure: push key and return to step 1.



Once the values have been checked - start bolting process.

Successful bolting is signaled by „OK“.



Confirm resp. the acknowledgment is automatically.



Remove the torque multiplier, place it on the next bolt/nut and continue with the bolting process.

“nOK” signalisation flashes (faulty bolting).



Check the setting values. Repeat the bolting operation, observing the relevant regulations for the bolting operation, e.g. use new bolts or new bolting material.

#### Application description:

Bolted connections are bolted with a torque specification and monitored at the same time. During the bolting process, the currently applied torque is always shown on the display and reaching the SET value is signaled by an „OK“. The maximum actual torque

applied is stored. If required, an automatic release angle can be set. This function enables a fast, secure “run free” of the *DMA* and also relieves torsional stresses within the torque multiplier.



# alkitronic® EB-S Battery driven Torque Multiplier

## 5.4.2 Bolting according to the torque/angle method (option)

### Settings mode 2 - with / without automatic release function

Start Screen



\* After a short time, the display jumps to the next image (example).

Step 1 Set bolting method

Confirm

Step 2 Set Pre-torque

Confirm



The setting steps of the torque values are in increments of 10 Nm (10 ft.lbs).

Step 3 Set angle of rotation

Confirm

Step 4 Set release angle

Confirm

If no automatic release function is desired, set release angle to „0“.

**Note on the procedure for the loosening angle:** This is not intended for loosening a bolt/nut, here only the release of tension between the torque multiplier and the bolted joint is established!

Correction procedure: push key and return to step 1.

Once the values have been checked - start bolting process.

Successful bolting is signaled by „OK“.

Confirm resp. the acknowledgment is automatically.

Remove the torque multiplier, place it on the next bolt/nut and continue with the bolting process.

„nOK“ signalisation flashes (faulty bolting).

**Possible causes:** The angle of rotation was not reached. The torque output of the *alkitronic® EB-S* is not sufficient for the bolted joint. Check the setting values. Repeat the bolting operation, observing the relevant regulations for the bolting operation, e.g. use new bolts or new bolting material. verwenden.

### Application description:

Bolted connections are tightened using a torque specification and additional rotation angle specification and at the same time monitored.

In the torque specification, the currently applied actual torque is shown in the display. When the preset target torque value is reached, the torque multiplier automatically switches to the rotation angle

function (the pushbutton must remain permanently activated). The currently measured rotation angles are shown in the display and upon reaching the preset angle of rotation, an „OK“ is shown in the display. The maximum applied actual torque and the actual rotational angle are stored and evaluated with an „OK“ or „nOK“ in the display.

# Operation and Maintenance Manual

## 5.4.3 Bolting according to the torque/angle method - Premium (option)

Settings mode 2 PREMIUM - torque limitation min / max. and with / without automatic release function

Start Screen



\* After a short time, the display jumps to the next image (example).

Step 1 Set bolting method

↓ ↑ Set Mode M2 Confirm (M)

Step 2 Set Pre-torque

↓ ↑ Torque 300 Nm Confirm (M)

Step 3 Set angle of rotation

↓ ↑ Angle → | 150° Confirm (M)

Step 4 Limitation: Set Torque min.

↓ ↑ MinTorque 1500 Nm Confirm (M)

Step 5 Limitation: Set Torque max.

↓ ↑ MaxTorque 2500 Nm Confirm (M)

Step 6 Set release angle

↓ ↑ Angle ← | -5° Confirm (M)

Correction procedure: push key and return to step 1.

(M) M2 300 Nm 150°, -5°

Successful bolting is signaled by „OK“.

OK Confirm (M)

„nOK“ signalisation flashes (faulty bolting).

nOK

**NOTE!** The setting steps of the torque values are in increments of 10 Nm (10 ft.lbs).

Limitation of max. torque

If no automatic release function is desired, set release angle to „0“.

**Note on the procedure for the loosening angle:** This is not intended for loosening a bolt/nut, here only the release of tension between the torque multiplier and the bolted joint is established!

Once the values have been checked - start bolting process.

Confirm resp. the acknowledgment is automatically. Remove the torque multiplier, place it on the next bolt/nut and continue with the bolting process.

**Possible causes:** The angle of rotation was not reached. Termination due to exceeding the torque limit. The torque output of the *alkitronic*® *EB-S* is not sufficient for the bolted joint. Check the setting values. Repeat the bolting operation, observing the relevant regulations for the bolting operation, e.g. use new bolts or new bolting material. verwenden.

### Application description:

The bolting process is identical to mode 2, but a minimum and maximum torque value can be stored to protect the bolt/nut or the bolting process in general from overload and damage. The bolting process in the torque/rotation angle method is monitored and simultaneously limited with an adjustable minimum and maximum torque.

The maximum selectable value corresponds to the maximum power range of the respective machine. If this torque value is exceeded during the bolting process, the process is aborted and evaluated with an „nOK“ in the display.

# alkitronic® EB-S Battery driven Torque Multiplier

## 5.4.4 Bolting with specification of turns (option)

### Settings Mode 3

Start screen



\* After a short time, the display jumps to the next image (example).

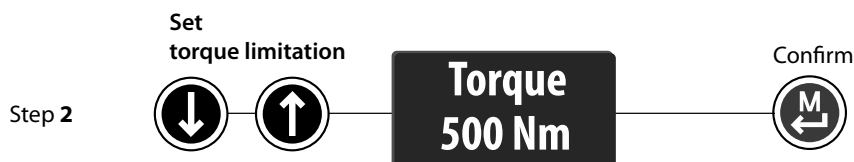

The setting steps of the torque values are in increments of 10 Nm (10 ft.lbs).



Correction procedure: push key and return to step 1.

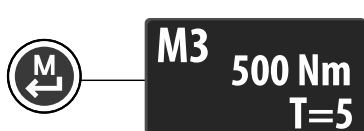

Once the values have been checked - start bolting process.

The SET number of revolutions reached is signaled by „OK“.



Confirm resp. the acknowledgment is automatically.



Remove the torque multiplier, place it on the next bolt/nut and continue with the bolting process.

“nOK” signalisation flashes (faulty bolting).



**Possible causes:** Exceeding the torque limit or the torque output of the *alkitronic® EB-S* is not sufficient for the bolted joint. Check the setting values. Repeat the bolting process in compliance with the relevant regulations for the bolting process.

### Application description:

A certain number of revolutions is specified for the output drive. The torque limiter monitors the process at the same time. The currently measured number of revolutions is shown in the display. As long as the pushbutton is held down, the *alkitronic® EB-S* counts the revolutions already made until the set number of revolutions is reached. It is possible to pause the output. The currently measured number of revolutions is stored temporarily. When the pushbutton is pressed again, the counter continues to run until the SET number of revolutions is reached.

### Note:

However, the temporary storage is deleted when the mode is changed or the device is restarted. When the number of revolutions is reached, the process is evaluated with an „OK“ in the display then recorded. If the set torque limit is exceeded, the process is aborted and a „nOK“ is shown then saved.

# Operation and Maintenance Manual

## 5.4.5 Documentation bolted joint and Bluetooth activation (option)

### Settings Mode 5

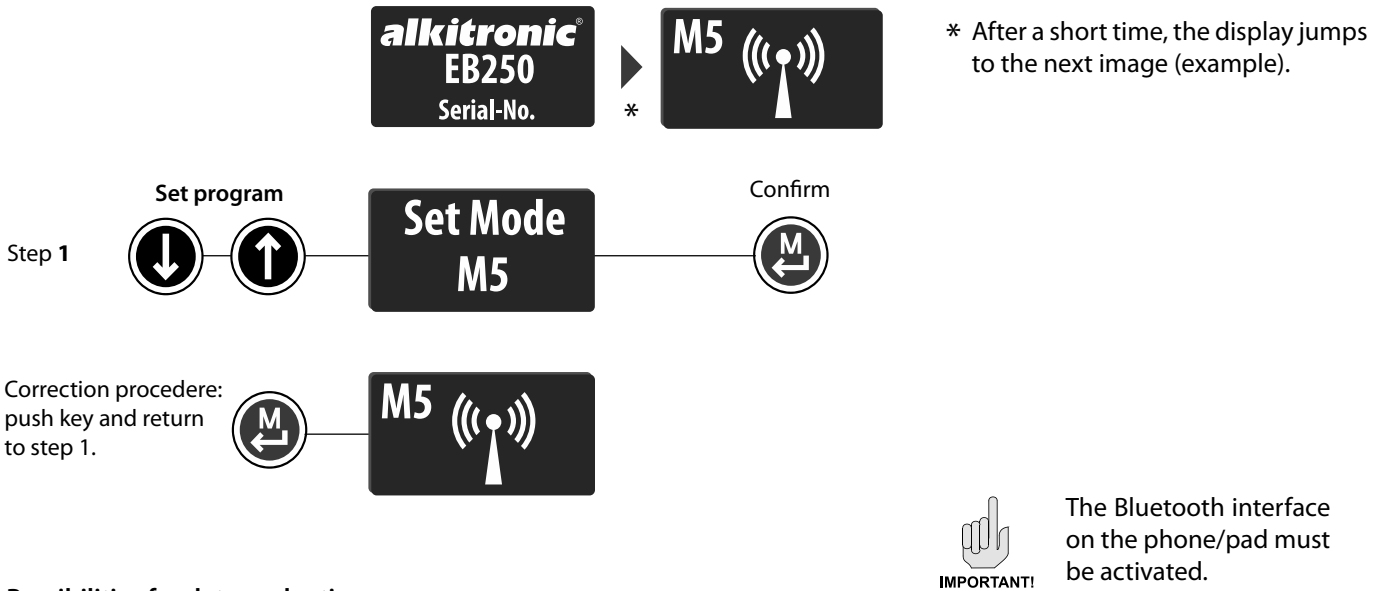

### Possibilities for data evaluation:

- In modes 1, 2 and 3, all bolting actions are documented
- In mode 2, the resulting maximum torque can also be reproduced during use in rotating angle application

### Contents of the CSV file:

- ID** - consecutive number for each stored tightening
- Mode** - mode used
- Target / actual values** - used target values and measured actual values
- Status** - Assessment of target / actual values for tightening status (SUCCESSFUL / ERROR)

In the CSV file, under the column „actual torque“ you can find the final torque of the rotation angle function of mode 2. This value is used for the direct determination of an emerging torque range, for example for the use of test and development purposes in the bolting application.

**CSV data set:** Example mode 1 (ID33-35) with 3 bolted connections, target MD in Nm and release angle 5°. Example of mode 2 (ID36-38) with 3 bolts, target MD, min,max MD in Nm, target angle and release angle 5°.

ID	Mode	Timestamp	Status	ActualTorque	TargetTorque	MinTorque	MaxTorque	ActualAngle	TargetAngle	ActualTurn	TargetTurn	Actual Release.angle	Target Release.angle
33	1	2020-05-29F13:21:38.016Z	OK	298	301	---	---	---	---	---	---	5	5
34	1	2020-05-29F13:22:38.016Z	nOK	420	301	---	---	---	---	---	---	0	5
35	1	2020-05-29F13:22:38.016Z	OK	302	301	---	---	---	---	---	---	5	5
36	2	2020-05-29F13:24:38.016Z	nOK	270	140	200	250	50	50	---	---	0	5
37	2	2020-05-29F13:25:38.016Z	OK	244	140	200	250	50	50	---	---	5	5
38	2	2020-05-29F13:25:38.016Z	OK	235	140	200	250	50	50	---	---	5	5

Legend: M<sub>D</sub> = Torque

### Application description:

Selecting mode 5 activates the Bluetooth interface and enables transmission. Provided Bluetooth is activated on the smartphone In the *alkitronic® App*, the relevant bolting cases for documentation can be narrowed down by selecting the desired download period (download from: date / time).

Up to 500 stored bolting joints can be downloaded with the associated *alkitronic® App* and sent by e-mail in the form of a CSV file. This makes the bolting data available in tabular form for analysis and documentation.

# alkitronic® EB-S Battery driven Torque Multiplier

## 5.4.6 The alkitronic® APP

Quick guide: Screens and selection of operating

You can find the **alkitronic® APP** download in the App Store (Apple) or Play Store (Android).

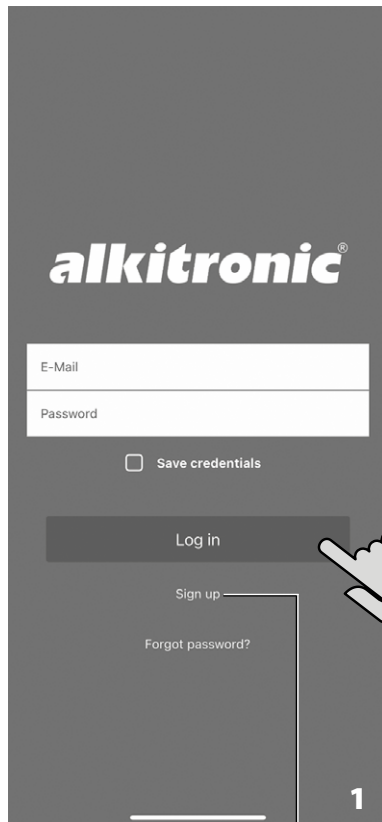

1

The screen views may differ from the images shown here, depending on the smartphone used.



Torque multiplier choice \*

Language selection

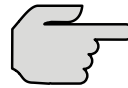

Settings

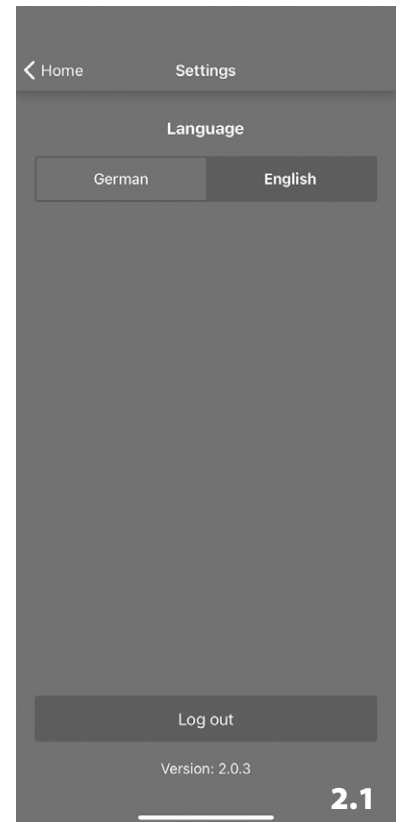

2.1

Collection of user data

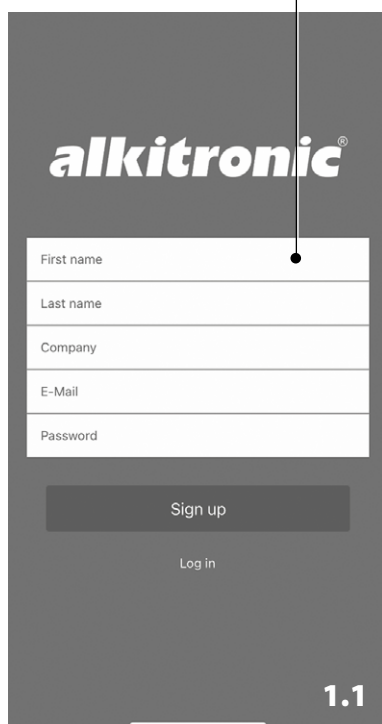

1.1



2

\*) To pair or search for an **alkitronic® EB-S** battery driven torque multiplier, the Bluetooth interface on the phone/pad must be activated.

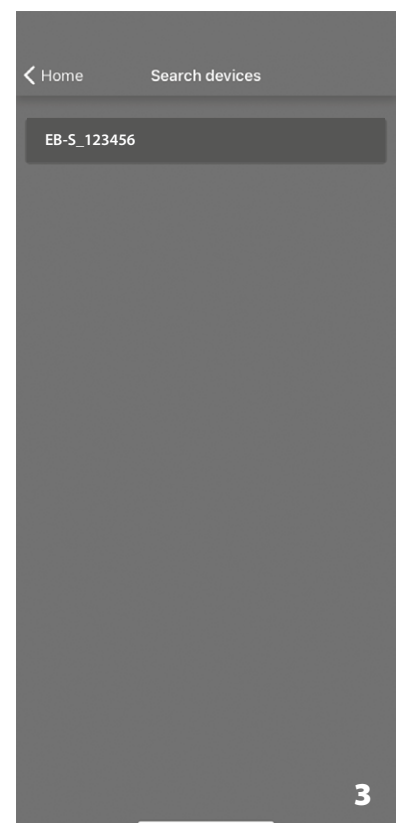

3



# Operation and Maintenance Manual

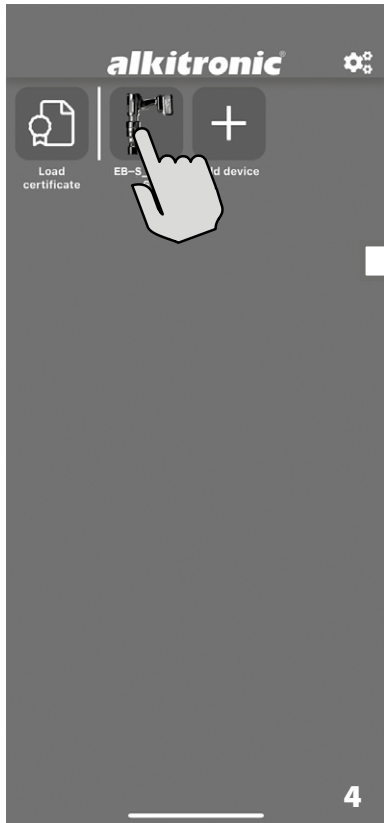

After the Torque Multiplier has been selected (Screen 4), all machine and production-related data can be called up.

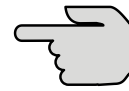

When tapping the CSV icon, the displayed bolted joint data (Screen 5.2) will be exported in a CSV data record.

Note:  
After transferring the data, this overview is no longer displayed.

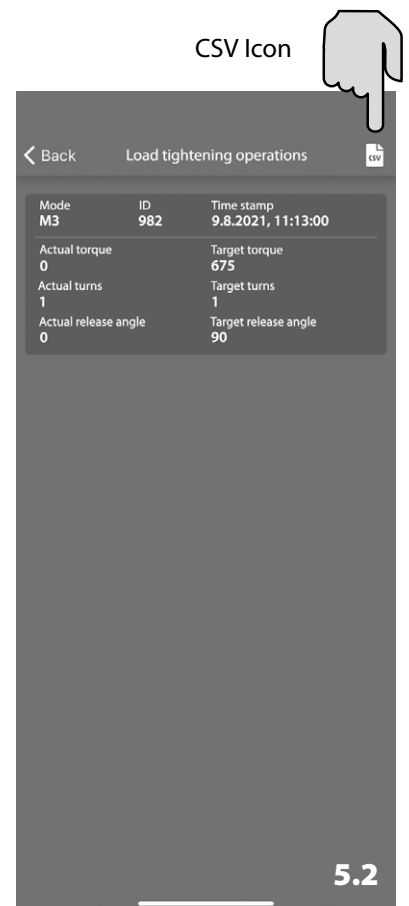
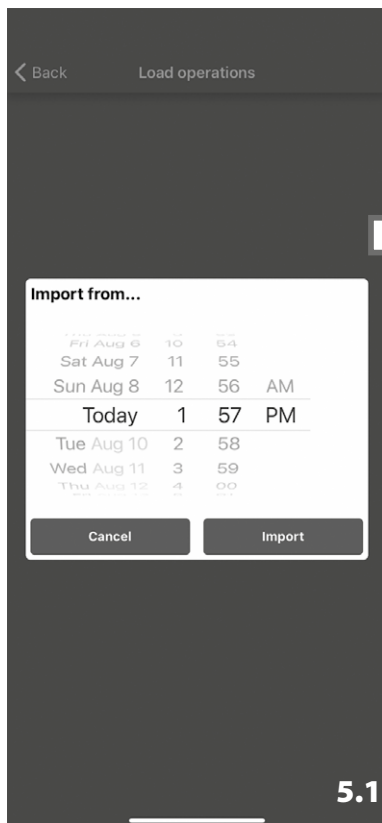

# alkitronic® EB-S Battery driven Torque Multiplier

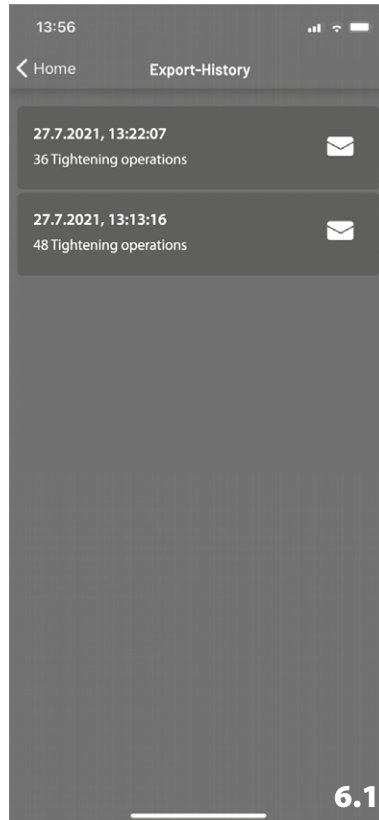

Display of the *alkitronic*® EB-S torque multiplier - specific properties (screen 7.1).

## Calibration certificate

With this function, the *alkitronic*® EB-S specific certificate can be transferred to the smartphone (as a supplement for the bolted joint documentation). As soon as the button is pressed, the camera function opens. This can be used to scan the QR code of the *alkitronic*® EB-S or the supplied calibration certificate.

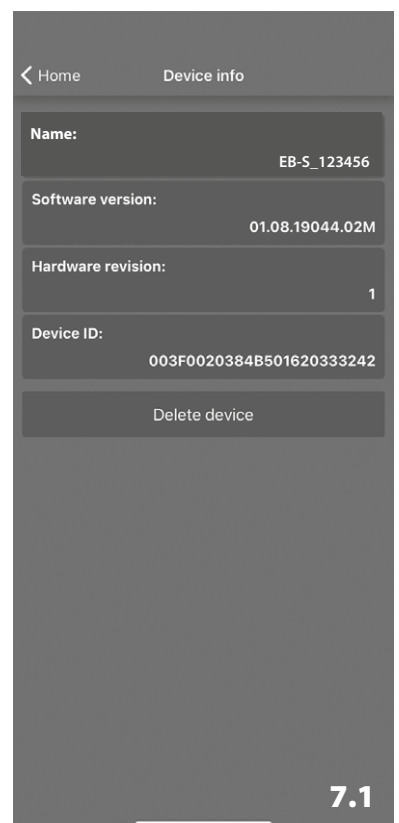

# Operation and Maintenance Manual

## 5.4.7 Error messages in the *alkitronic*® *EB-S* operating area

Error messages are always displayed flashing and inversely.



General error Message

Error message as hexadecimal figure



Errors can be reset by using the “M” button, provided the cause is eliminated. If this fails, your *alkitronic*® *partner* will be pleased to help you. Please take a note of the error code and report it to our customer service.



Error display electrical supply

Warning initiated due to faulty power/voltage supply (Battery). E.g. by undervoltage



General error display excessive temperature

Temperature errors cannot be reset using the “M” button. Resetting is done automatically when temperature thresholds fall again below the limit.

To assure safe operation various temperature levels of the torque multiplier are controlled. A switch-off during a bolting process is however possible if the preset max. temperature limits are exceeded.



**TEMP-warning display**  
„TEMP“ warning is flashing

### Reactions



**IMPORTANT!**

**A - TEMP Error:**  
The bolting process is blocked/cancelled.

**B - TEMP Warning during bolting:**  
Finish the bolting process in progress.

**C - TEMP Warning prior to a bolting process:**  
The bolting process is blocked until the temperature is back to normal. “TEMP” warning will then no longer show.

### General warnings



**IMPORTANT!**

Service warning



**IMPORTANT!**

Under excessive use/high loads or in case of many operation hours we recommend that calibration and service is carried out at shorter intervals than the recommended 12 months. In this case a service warning appears in the display. You can acknowledge the message with the “M” button. From this time on the information is shown at every restart of the torque multiplier.



Note additionally **page 20**, item **9.4 Maintenance intervals**.

# alkitronic® EB-S Battery driven Torque Multiplier

## 6. Mechanic Operation *alkitronic® EB-S*



The *alkitronic® EB-S* electric torque multiplier must not be damp, neither operated nor stored in moist or humid environment. Otherwise an additional rain protection must be provided on site.

### 6.1 Placing tool in operation



IMPORTANT!

*alkitronic® STACO/STABI/STA/DMA* (specific nuts, connectors, adaptors and reaction absorbers) available as accessories, are needed in accordance with a specific bolt joint.

The *alkitronic® EB-S* must be disconnected from the battery pack before making any changing accessories.

- Accessories may be placed on the tool drive side. Make sure every part is placed correctly and secured (in compliance with item 6.2 Preparing for bolting).
- Replace worn or damaged accessories immediately. For replacement use original *alkitronic®* accessories only. This rule will reduce the risk of malfunction and serious personal injury.



IMPORTANT!

#### We strongly recommend

running the *alkitronic® EB-S* in at idle speed, at high torque setting for 30 seconds before use.



Thus, among other things, the operating greases are brought to viscosity, the moving parts to operating temperature, and a higher degree of efficiency is achieved.

The torque values according to the calibration certificate are thus reproduced as accurately as possible from the very first bolting operation.



NOTE!

#### *alkitronic®* accessories

For each fastening the original accessories.



### 6.2 Preparing for bolting

- Place the *alkitronic® EB-S* on a flat surface.
- If the *DMA* is secured with a safety screw - turn out safety screw completely (the position of the screw can vary dependent on type).
- Insert *DMA* reaction absorber (1) onto toothing (4), turn in the safety screw completely - the *DMA* is secured.

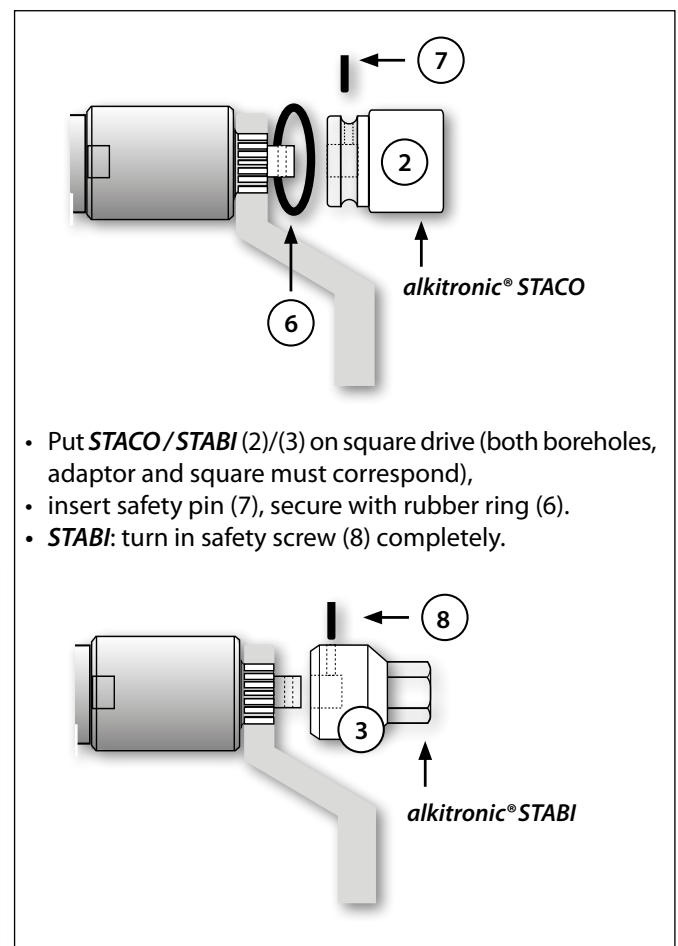
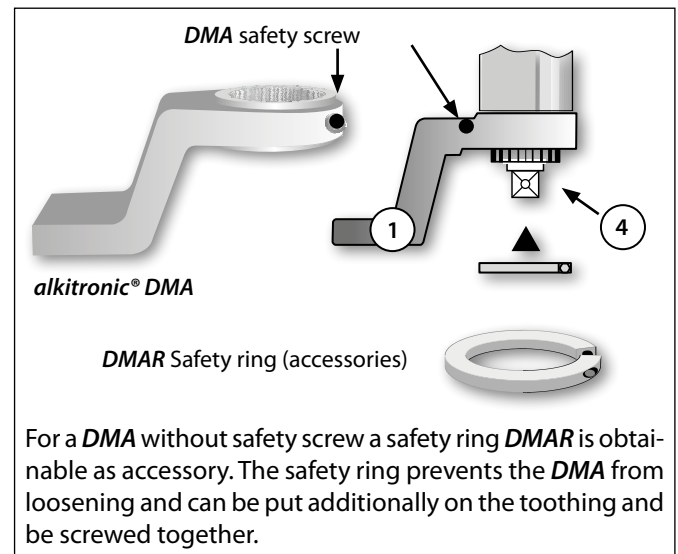

# Operation and Maintenance Manual

## 6.3 Safety instructions operation



Comply with all applicable local, state and national electrical and safety regulations.

Always carry out a function inspection and safety check - no working with damaged parts!



Keep your hair, clothing, and gloves away from moving parts. Loose clothes, jewelry or long hair can be caught in moving parts (*alkitronic*<sup>®</sup> *DMA/STACO/STABI/STA*).

Maintain a safety distance when tightening bolts or nuts. Do not leave the torque multiplier unattended during use. A rapid "switch off" in case of emergency must be always ensured.

Keep proper footing and balance at all times. This enables better control of the torque multiplier in unexpected situations.

### 6.3.1 Tightening and loosening

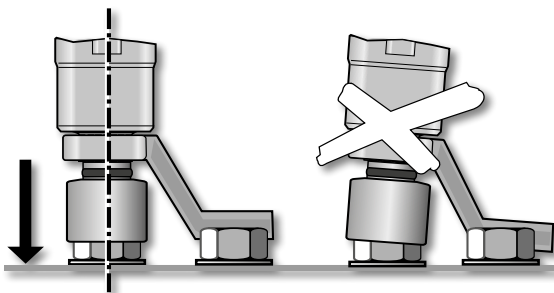

Always place *STACO/STABI* completely on the bolt/nut. Provision of a safe and stable counter mounting is essential. For individual *DMA* solutions, your *alkitronic*<sup>®</sup> *Partner* will be pleased to assist you.



Improper bolting connection or incorrect reaction support may cause:

- Strain breakage in *STACO/STABI* adaptors, bearing or output square drive;
- Bruises or even life-threatening injuries (parts splintering off);
- "Shut-off" torque failures.



In addition, non-compliance of any above items will void all warranty claims.

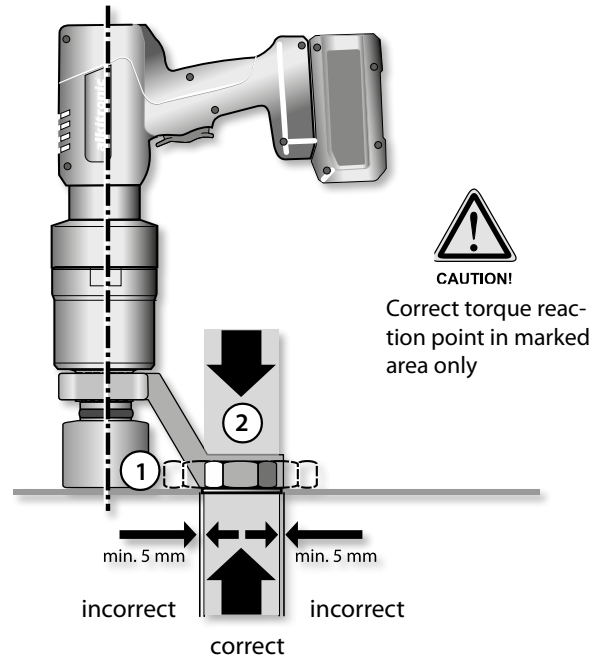
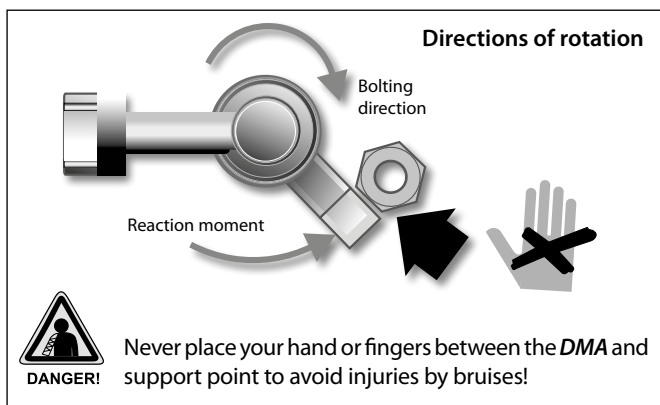

### Operation steps *alkitronic*<sup>®</sup> *EB-S*

The battery is already fitted and the bolting parameters have been set:

- Place the *alkitronic*<sup>®</sup> *EB-S* with *alkitronic*<sup>®</sup> *STACO/STABI* completely on bolt/nut.
- The *DMA* or torque-on recipient of the torque multiplier must be at the same height as the socket/adaptor to take the reaction moment.
- A sure, stable counter-mount (2) must be ensured.
- Always keep the torque multiplier in axis line to the bolt during bolting process.
- Use the rocker switch to trigger the bolting process in the right direction of rotation.
- The drive stops when achieving the desired torque or value.

### Place *alkitronic*<sup>®</sup> *EB-S* on the next bolt/nut

If the automatic release function is not set and the torque multiplier is not removable of the bolted joint (torsional forces caused):

- Briefly switch on the *alkitronic*<sup>®</sup> *EB-S* with the rocker button. Direction of rotation left until the *DMA* (reaction arm) is free. Release the rocker button
- Place the machine on the next bolt/nut and repeat the tightening process.

**For your information:** For loosening, a significantly higher loosening torque (depending on the bolt joint, up to 50%) may be necessary than the torque originally applied during tightening.

### Active automatic release function:

- If the tension release function is preset, the *DMA* is automatically „released“. Then place the *alkitronic*<sup>®</sup> *EB-S* on the next bolt/nut and continue the bolting process.
- **End of the bolting**



# alkitronic® EB-S Battery driven Torque Multiplier

- **End of the bolting process**  
If the bolting process was error-free („OK“ - shown in the display), confirm the process. (↔)
- Remove the **alkitronic® EB-S**, another bolting process can be started.



IMPORTANT!

#### Application release function:

This is not intended for loosening a bolt/nut. Use the automatic release function only to release tension inside the **alkitronic® EB-S**.



CAUTION!

#### Do not retighten the nut/bolt.

Because the preset torque is exceeded and it can lead to damage to the torque multiplier or to the bolt / threaded bolt.

## Loosening the bolted joint

In principle, measures and operating behavior are largely identical to those for tightening, e.g. ensure a stable counter-mount and correct reaction point; keep the torque multiplier in axis line to the bolt, etc.

For loosening, however, a significantly higher loosening torque (depending on the bolt joint, up to 50%) may be necessary than the torque originally applied during tightening.

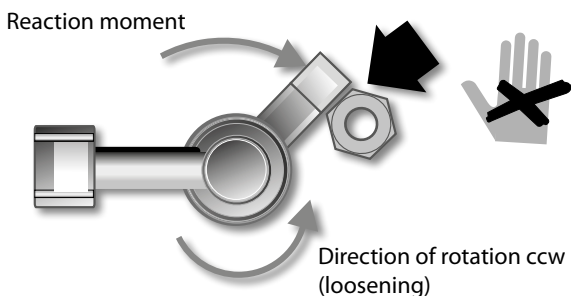

CAUTION!

If the torque multiplier cannot loosen the bolt joint and it switches off automatically for safety reasons - **do not press the pushbutton again.**

The torque can build up disproportionately and cause damage to the gear unit!  
If the bolt/nut cannot be opened with the preset torque, interrupt the loosening process!  
Change the direction of rotation and start the torque multiplier briefly to relieve torsional stresses in the torque multiplier. Then set the next higher torque in the operating area. Torque multiplier with direction of rotation ccw - start loosening process again.

In case the torque is not sufficient even at the highest torque level - to loosen the bolt/nut - change to a stronger **alkitronic®** product.

## 7. End of Work / Interruption / Cleaning



IMPORTANT!

Place the **alkitronic® EB-S** on a flat, dry surface - out of reach of children. Remove the battery pack.



IMPORTANT!

Keep the ventilation slots and motor housing regularly free of dust and dirt. Clean the unit with a damp, clean cloth or blow it out with compressed air at low pressure.

Do not use any cleaning agents or solvents; which could attack the plastic parts of the **alkitronic® EB-S**. Make sure that no water can get into the housing. Water penetration increases the risk of damage to the electronics.

## 8. Functional and Operational Tests

### 8.1 Optical and mechanical inspection



IMPORTANT!

Check for intactness regularly, power cord and plug (Charger Station), display and operating elements, gear box, drive element, housing and accessories (e.g. reaction absorber *DMA*, adaptors). Before further use of the **alkitronic® EB-S**, damaged parts should be properly repaired or replaced. Serious damages and many accidents are caused by poorly inspected tools.



CAUTION!

In cases of performance loss, strong gear noises or recognisable heavy damages a repair is to be carried out immediately. In the event of repairs the **alkitronic® EB-S** (in original package) must be sent to the appropriate **alkitronic® Partner** or directly to alki Technik GmbH.

**The following operation and service requests should be strictly observed!**

# Operation and Maintenance Manual

## 9. Storage / Maintenance / Service

### 9.1 Accessories change

Note item "6.2 Preparing for bolting" and carry out the described steps in reverse order.

### 9.2 Storage



The *alkitronic*<sup>®</sup> *EB-S* should be stored dry, cooled down and dust-free in *alkitronic*<sup>®</sup> original packaging or in other lockable containers. Warmth and humidity may lead to oxidations in gear parts as well as in other parts within the tool housing. Following these rules will reduce the risk of malfunctions, electronics and motor damage. When storing, make sure that the battery pack is removed from the *alkitronic*<sup>®</sup> *EB-S*.

### 9.3. Taking out of operation



In case that the *alkitronic*<sup>®</sup> *EB-S* is stored for a prolonged period of time: Store the tool cleaned in a closeable dry room, out of the reach of children. Avoid excessive exposure to heat and moisture. Moving/rotating tool parts are to be preserved against Oxidation.

See supplementary points 7 and 9.2

### 9.4 Maintenance intervals



The *alkitronic*<sup>®</sup> *EB-S* is an extremely efficient and robust product. Nevertheless to ensure lifetime and performance for years, a regular maintenance is necessary (**Performance-Check, Motor-Check, Safety-Check, Calibration-Service**).

#### Maintenance periode / Service



The torque multiplier must be submitted at least once a year for inspection.

After high stresses/loads or also hours of operation a calibration and servicing must be carried out in shorter periods. In this case a service warning appears in the display to remind the user. Acknowledge the message with the "M" button. From this time on the information is shown at every restart of the torque multiplier.

**SERVICE**



In addition to the number of operating hours, the number of bolted joints is also a major factor in the use of the *alkitronic*<sup>®</sup> calibration service. The table shows a type-specific number of bolted joints from which an inspection is to be carried out.

<i>alkitronic</i> <sup>®</sup> Type	Bolted joints	Square drive
EB 80 / 150	<b>12 500</b>	3/4"
EB 180 / 250	<b>10 000</b>	1"
EB 350 / 400	<b>8 000</b>	1"
EB 480 / 600	<b>7 000</b>	1 1/2"



Upon unusual gear or bearing noises, a lubrication of the transmission parts is urgently recommended in order to exclude consequential damage. In the event of repairs the *alkitronic*<sup>®</sup> *EB-S* must be sent to the appropriate *alkitronic*<sup>®</sup> *Partner* or directly to alki Technik GmbH in original package.

## 10. Technical Notes

### Notes on the safety shut-off



In order to avoid faulty bolted connections and/or bolt damage, each *alkitronic*<sup>®</sup> *EB-S* is equipped with a temperature-controlled safety shut-off. When the shut-off is active, the letters "Off" flash in the O-LED display in the operating area. After a short cooling time, the *alkitronic*<sup>®</sup> *EB-S* is ready for use again ("Off" no longer flashes).

## 11. Acoustic Emission and Vibration

Sound pressure level at max. idling speed:  
Models *alkitronic*<sup>®</sup> *EB-S* 75 - 80 dB(A)  
Sound pressure levels were measured for different work cycles, with the sensor positioned at a distance of 1 m to the geometric centre of the machine.

Low vibration shortly before reaching the pre-set torque.

## 12. Environmental Protection

**Do not throw battery packs into water or dispose of them in lakes / natural landscapes.**



Protect the environment and do not dispose of power tools, equipment and battery packs in household waste. Follow national regulations for separate collection and recycling of disused machines, packaging and accessories. Discharge the battery pack in the power tool before disposing of it. Secure the contacts against short-circuiting (e.g. insulate with adhesive tape).

# alkitronic® EB-S Battery driven Torque Multiplier

## 13. Conformity Declaration

Technical documents at EB-S and Serial Number (e.g. YOM\* 2022: 221....), meet all relevant requirements of directives:

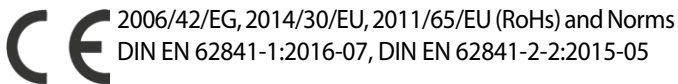

Station Power X-Fastcharger 4A (Ref.-No. 45.121.03 Einhell):  
2014/30/EU, 2011/65/EU\_(EU)2015/863. Standard references:  
EN 60335-1, EN 60335-2-29, EN 62233, EN 61000-3-2, EN 55014-1,  
EN 55014-2

2022-10-25 Alexander Kipfelsberger,  
Managing Director

Technical documents at alki Technik GmbH,  
Unterlettenweg 4, 85051 Ingolstadt / Germany.

\*) YOM Year of Manufacture

## 14. Technical Data

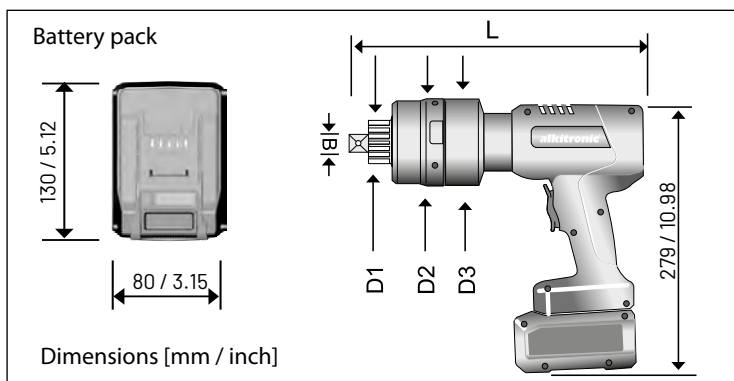

### Models EB-S

Type		EB-S 80	EB-S 150	EB-S 180	EB-S 250	EB-S 350	EB-S 400	EB-S 480	EB-S 600
Torque ranges (approx.)*	Nm	110-850	150-1400	250-1800	350-2500	480-3500	560-4000	650-4800	800-6000
	ft.lbs	90-620	110-1030	190-1330	260-1840	360-2580	410-2950	480-3540	590-4420
Square drive	B	3/4"	3/4"	1"	1"	1"	1"	1 1/2"	1 1/2"
Diameter (approx.)	D <sub>1</sub>	41/1.61	41/1.61	54/2.13	54/2.13	54/2.13	54/2.13	72/2.83	72/2.83
Diameter (approx.)	D <sub>2</sub>	88/3.46	88/3.46	88/3.46	88/3.46	88/3.46	88/3.46	98/3.86	109/4.29
Diameter (approx.)	D <sub>3</sub>	88/3.46	88/3.46	88/3.46	88/3.46	88/3.46	88/3.46	88/3.46	88/3.46
Length (approx.)	L	330/13.00	330/13.00	375/14.76	382/15.04	382/15.04	382/15.04	400/15.75	407/16.02
Weight w/o DMA**, Battery (appr.)		5.3/11.68	5.3/11.68	6.7/14.77	7.3/16.09	7.3/16.09	7.3/16.09	9.3/20.50	10.5/23.15

\*) For loosening, a significantly higher loosening torque (depending on the bolt case, up to 50%) may be necessary than the torque originally applied during tightening. \*\* Torque reaction arm. We will gladly advise you in detail.

## 15. Additional Safety Instructions

according to DIN EN 62841-1 (VDE 0740-1):2016-07,  
EN 62841-1:2015 + AC:2015

The term „power tool“ used in the safety instructions refers to mains-operated power tools (with power cord) or battery-driven power tools (without power cord).

### 1. Workplace safety

- a) **Keep your working area clean and well lighted.**  
Disorder or unlighted working areas can lead to accidents.
- b) **Do not work with the power tool in explosive atmospheres where flammable liquids, gases or dusts are present.**  
Power tools produce sparks that can ignite the dust or fumes.
- c) **Keep children and other persons away while using the power tool.**  
You may lose control of the power tool if distracted.

### 2. Electrical safety

- a) **The power tool's connector plug must fit into the socket. Do not modify the plug in any way. Do not use adapter plugs together with protective grounded power tools.**  
Unmodified plugs and matching sockets reduce the risk of electric shock.
- b) **Avoid physical contact with grounded surfaces such as pipes, heaters, stoves, and refrigerators.**  
There is an increased risk from electric shock if your body is grounded.
- c) **Keep power tools away from rain or wet conditions.**  
Water getting into a power tool increases the risk of electric shock.
- d) **Do not misuse the power cord to carry, hang or unplug the power tool. Keep the power cord away from heat, oil, sharp edges or moving parts.**  
Damaged or tangled power cords increase the risk of electric shock.
- e) **When working outdoors with a power tool, use only extension cords that are suitable for outdoor use.**  
Using an extension cord suitable for outdoor use reduces the risk of electric shock.
- f) **If operation of the power tool in a damp environment cannot be avoided, use a residual current device (RCD).**  
The use of a residual current device (RCD) reduces the risk of electric shock.

### 3. Safety of persons

- a) **Be alert, pay attention to what you are doing, and use common sense when working with a power tool. Do not use a power tool when you are tired or under the influence of drugs, alcohol or medication.**  
A moment of carelessness while using a power tool can result in serious injury.
- b) **Wear personal protective equipment and always safety glasses.**  
Wearing personal protective equipment, such as dust mask, non-slip safety shoes, safety helmet or hearing protection, depending on the type and use of the power tool, reduces the risk of injury.
- c) **Avoid unintentional start-up. Make sure the power tool is switched off before connecting it to the power supply and/or battery, picking it up or carrying it.**  
If you have your finger on the switch while carrying the power tool or connect the power tool to the power supply while it is switched on, this can lead to accidents.
- d) **Remove adjustment tools or wrenches before turning on the power tool.**  
A tool or wrench that is in a rotating part of the power tool can cause injury.
- e) **Avoid abnormal posture. Ensure that you stand securely and maintain your balance at all times.**  
This will help you control the power tool in unexpected situations.
- f) **Wear appropriate clothing. Do not wear loose clothing or jewelry. Keep hair and clothing away from moving parts.**  
Loose clothing, jewelry or long hair can be caught by moving parts.
- g) **If dust extraction and dust collection equipment can be fitted, it must be connected and used correctly.**  
Use of a dust extraction system can reduce hazards from dust.
- h) **Do not lull yourself into a false sense of security and do not ignore the safety rules for power tools, even if you are familiar with the power tool after using it many times.**  
Careless actions can lead to serious injuries within fractions of a second.

# alkitronic® EB-S Battery driven Torque Multiplier

## 4. Use and handling of the power tool

- a) **Do not overload the power tool. Use the power tool intended for your work.**  
With the appropriate power tool, you will work better and safer in the specified power range.
- b) **Do not use a power tool whose switch is defective.**  
A power tool that cannot be switched on or off is dangerous and must be repaired.
- c) **Unplug the power tool and/or remove a removable battery before making any equipment adjustments, changing insert tool parts, or putting the power tool away.**  
This precaution prevents unintentional starting of the power tool.
- d) **Keep unused power tools out of the reach of children. Do not allow anyone to use the power tool who is unfamiliar with it or has not read these instructions.**  
Power tools are dangerous when used by inexperienced persons.
- e) **Take care of power tools and application tools. Check that moving parts are working properly and are not jammed, that parts are not broken or damaged in such a way that the function of the power tool is impaired. Have damaged parts repaired before using the power tool.**  
Many accidents are caused by poorly maintained power tools.
- f) **Keep cutting tools sharp and clean.**  
Carefully maintained cutting tools with sharp cutting edges jam less and are easier to guide.
- g) **Use power tools, insert tools, etc. according to these instructions. Take into account the working conditions and the activity to be performed.**  
The use of power tools for applications other than those for which they are intended can lead to dangerous situations.
- h) **Keep handles and grip surfaces dry, clean and free of oil and grease.**  
Slippery handles and grip surfaces do not allow safe operation and control of the power tool in unforeseen situations.

## 5. Service

- a) **Only repair your power tool by qualified personnel and only with original spare parts.**  
This will ensure that the safety of the power tool is maintained.



## YOUR PLUS FOR MORE PERFORMANCE

### Increased quality

Premium production  
Highest quality materials  
Long product life cycles  
Since 1984 experience in bolting technology  
Made in Germany – international patents

### Increased precision

Precise, customer-specific torques  
High repeatability  
Reliability in permanent operation  
Documentation of tightening results  
Automatic shut-off

### Increased productivity

Quicker tightening without reworking  
No environmentally caused failures (IP54, ATEX)  
High work safety  
Easy to use: clear, simple instructions  
Low maintenance and cost efficient

### Better service

Technical advice on site  
Training offers  
Manufacturer's calibration and certification  
Lifecycle support  
Spare part and repair service

alki TECHNIK GmbH

Development, Production and Distribution of Bolting Systems

Unterlettenweg 4 – 85051 Ingolstadt/Germany – fon +49 841 97499-0 – fax +49 841 97499-90  
info@alkitronic.com – www.alkitronic.com

### EXTRACT FROM OUR PRODUCT RANGE

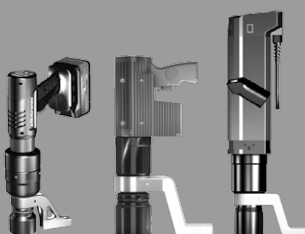

**alkitronic XE-SERIES**

THE ELECTRICS



**alkitronic XP-SERIES**

THE PNEUMATICS

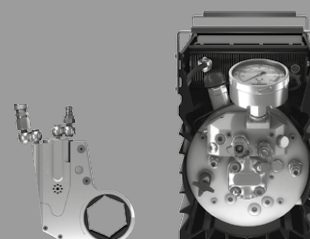

**alkitronic XH-SERIES**

THE HYDRAULICS



**alkitronic XM-SERIES**

THE MANUALS